



User Manual

XG25-40KTR Grid-tied Solar Inverter



INVT Solar Technology (Shenzhen) Co., Ltd.

Preface

The manual is intended to provide detailed information of product information, installation, application, trouble shooting, precautions and maintenance of iMars series grid-tied solar inverters. The manual does not contain all the information of solar system. Please read this manual carefully and follow all safety precautions seriously before any moving, installation, operation and maintenance to ensure correct use and high performance of operation on the inverter.

The use of the iMars series grid-tied solar inverters must comply with local laws and regulations on grid-tied power generation.

The manual needs to be kept well and be available at all times.

All rights reserved. The contents in this document are subject to change without notice.

There might be some deviations on actual inverter and data due to product updating, please refer to the actual product.

Content

Preface	i
Content	ii
1 Safety precautions	1
1.1 Warning marks	1
1.2 Safety guidance	1
1.2.1 Transport and installation	3
1.2.2 Grid-tied operation	3
1.2.3 Maintenance and inspection	4
1.2.4 Waste disposal	4
2 Product overview	5
2.1 Grid-tied PV power generation system	5
2.1.1 Supported grid connection structure	5
2.2 Product appearance	6
2.3 Nameplate	7
2.4 Product model	8
2.5 Outline dimension and weight	9
2.6 The front panel	10
2.6.1 LED panel (Modern design)	10
2.7 LCD display and operation	10
2.7.1 LED indicator definition and LCD display wake-up	11
2.7.2 Main screen display	12
2.7.3 Menu screen display	12
2.7.4 Basic Information	13
2.7.5 Basic Setting	14
2.7.6 Advanced Options	15
2.8 Bottom of chassis	16
3 Storage	17
4 Installation	18
4.1 Unpacking confirmation	18
4.2 Preparation before installation	19
4.2.1 Installation tool	19

4.2.2 Installation environment	20
4.3 Space requirements	20
4.4 Dimensions of the mounting bracket	22
4.5 Wall installation	22
4.6 Installation of inverter	23
5 Electrical connection	25
5.1 Overview of electrical connection	25
5.2 Connect the protective earth wire	25
5.3 Connection of solar string	26
5.4 DRM & RS485 terminal connection	27
5.5 Three-phase inverter grid connection	28
5.5.1 Cable specifications	29
5.5.2 Grid connection	29
5.5.3 Parallel operation requirements	30
6 Running	31
6.1 Inspection before running	31
6.2 Inverter grid-tied running	31
6.3 Inverter stop	32
6.4 Regular inspection and maintenance	32
6.4.1 Regular inspection and maintenance list	32
6.4.2 Maintenance guidance	33
7 Troubleshooting	35
8 Contact us	38
9 Appendix	39

1 Safety precautions

iMars series grid-tied solar inverters are designed and tested strictly in accordance with relevant international safety standards. As an electrical and electronic device, all relevant safety regulations must be strictly complied during installation, operation, and maintenance. Incorrect use or misuse may result in:









- Injury to the life and personal safety of the operator or other people.
- Damage to the inverter or other property belonging to the operator or other people.

In order to avoid personal injury, damage to the inverter or other devices, please strictly observe the following safety precautions.

This chapter mainly describes various warning symbols in operation manual and provides safety instructions for the installation, operation, maintenance and use of the iMars series grid-tied solar inverters.







1.1 Warning marks

Warning marks is alerting users to conditions which may cause serious physical injury or death, or damage to the device. They also tell users how to prevent the dangers. The warning marks used in this operation manual are shown below:

Mark	Name	Instruction	Abbreviation
 Danger	Danger	Serious physical injury or even death may occur if not follow relevant requirements.	
 Warning	Warning	Physical injury or damage to the device may occur if not follow relevant requirements.	
 Forbid	Electrostatic sensitive	Damage may occur if relevant requirements are not followed.	
 Hot	High temperature	Do not touch the base of the inverter as it will become hot.	
Note	Note	The procedures taken for ensuring proper operation.	Note

1.2 Safety guidance

	<ul style="list-style-type: none"> ● After receiving this product, first please confirm the product package is intact. If any question, please contact the logistic company or local distributor immediately. ● The installation and operation of PV inverter must be carried out by professional
-------------------------------------------------------------------------------------	---------------------------------------------------------------------------------------------------------------------------------------------------------------------------------------------------------------------------------------------------------------------------------------------------------------------------

	<p>technicians who have received professional trainings and thoroughly familiar with all the contents in this manual and the safety requirements of the electrical system.</p> <ul style="list-style-type: none"> ● Do not carry out cable connection/disconnection, cover open for inspection and unit replacement operations on the inverter when power is connected. Before wiring and inspection, users must confirm the breakers on DC and AC side are disconnected and wait for at least 5 minutes.
	<ul style="list-style-type: none"> ● Ensure there is no strong electromagnetic interference caused by other electronic or electrical devices around the installation site. ● Do not refit the inverter unless authorized. ● All the electrical installation must conform to local and national electrical standards.
	<ul style="list-style-type: none"> ● Do not touch the housing of the inverter or the radiator to avoid scald as they may become hot during operation.
	<ul style="list-style-type: none"> ● Ground with proper technics before operation.
	<ul style="list-style-type: none"> ● Do not open the surface cover of the inverter unless authorized. The electronic components inside the inverter are electrostatic sensitive. Do take proper anti-electrostatic measures during authorized operation.
	<ul style="list-style-type: none"> ● Grounding mark. The inverter must be reliably grounded.
	<ul style="list-style-type: none"> ● Discharging mark. Ensure that DC and AC side circuit breakers have been disconnected and wait at least 5 minutes before wiring and checking.
<p>Note: Technical personnel who can perform installation, wiring, commissioning, maintenance, troubleshooting and replacement of the iMars series grid-tied solar inverters must meet the following requirements:</p>	
<ul style="list-style-type: none"> ● Operators need professional training. ● Operators must read this manual completely and master the related safety precautions. ● Operators need to be familiar with the relevant safety regulations for electrical systems. ● Operators need to be fully familiar with the composition and operating principle of the entire grid-tied solar power generation system and related standards of the countries/regions in which the project is located. ● Operators must wear personal protective equipment. 	

1.2.1 Transport and installation

	<ul style="list-style-type: none"> ● During storage or transport, ensure the inverter package and the chassis is intact, dry and clean. ● The movement and installation of the inverter require at least two persons due to its heavy weight. ● Select proper tools for movement and installation to ensure the inverter can operate normally and avoid physical injury. The installation personnel must take mechanical protective measures such as wearing anti-drop shoes or working clothes to protect physical security. ● The inverter must be installed by professional technicians. ● Do not store, or install the inverter on or close to flammable and explosive objects;– ● Do not install the inverter in the place where children and other public can easily touch ● Remove the metal accessories in hands e.g. ring or bracelet before device installation and electrical connection to avoid electric shock. ● The solar cell module exposed to the sunlight may generate dangerous voltage. Users must cover the solar cell with fully-lightproof materials before electrical connection ● The inverter input voltage cannot exceed the max input voltage, otherwise the inverter may be damaged. ● Grid-tied PV inverter is not applicable to the positive or negative ground system of solar cell panel. ● Ensure inverter PE is grounded properly, otherwise the inverter cannot run normally. ● Ensure the inverter is installed firmly and electrical wiring is reliable.
-----------------------------------------------------------------------------------	-------------------------------------------------------------------------------------------------------------------------------------------------------------------------------------------------------------------------------------------------------------------------------------------------------------------------------------------------------------------------------------------------------------------------------------------------------------------------------------------------------------------------------------------------------------------------------------------------------------------------------------------------------------------------------------------------------------------------------------------------------------------------------------------------------------------------------------------------------------------------------------------------------------------------------------------------------------------------------------------------------------------------------------------------------------------------------------------------------------------------------------------------------------------------------------------------------------------------------------------------------------------------------------------------------------------------------------------------------------------------------------------------------------------------------------------------------------------------------------------------------------------------------------------------------------------------------------------------------------------

Note: Grid-tied PV inverter is only suitable for crystalline silicon solar module.

1.2.2 Grid-tied operation

	<ul style="list-style-type: none"> ● Permissions by local electric power agency must be obtained and the inverter grid-tied power generation operation must be done by professional technicians. ● All electrical connections must meet the electrical standards of the countries/regions in which the project is located. ● Ensure the inverter is installed firmly and electrical wiring is reliable before operating on the inverter. ● Do not open the inverter when it is running or connecting power
-------------------------------------------------------------------------------------	------------------------------------------------------------------------------------------------------------------------------------------------------------------------------------------------------------------------------------------------------------------------------------------------------------------------------------------------------------------------------------------------------------------------------------------------------------------------------------------------------------------------------------------------------

1.2.3 Maintenance and inspection

	<ul style="list-style-type: none"> ● The maintenance, inspection and repair of the inverter must be done by well trained and qualified professional technicians. ● Contact distributor or manufacture for inverter repairing. ● In order to avoid irrelevant personnel entering the maintenance area during maintenance, temporary warning labels must be placed to warn non-professionals to enter or please isolate with fences. ● Before carrying out any maintenance operations, users must disconnect the breaker on grid side, then disconnect the DC breaker and wait at least 5 minutes until the internal parts of inverter are fully discharged. ● The internal of inverter are mostly electrostatic-sensitive circuits and parts, users must follow electrostatic protection (rules) and take anti-electrostatic measures. ● Do not use components provided by other companies when repairing the inverter. ● The inverter can be started again for grid-tied power generation only after confirming there is no fault that may impact the safety performance of the inverter. ● Do not get close to or touch the grid or any metal conductive parts in the PV power generation system during operation, otherwise electric shock or fire may occur. Take note of any safety marks and instructions such as "Danger, electric shock risk".
-----------------------------------------------------------------------------------	-------------------------------------------------------------------------------------------------------------------------------------------------------------------------------------------------------------------------------------------------------------------------------------------------------------------------------------------------------------------------------------------------------------------------------------------------------------------------------------------------------------------------------------------------------------------------------------------------------------------------------------------------------------------------------------------------------------------------------------------------------------------------------------------------------------------------------------------------------------------------------------------------------------------------------------------------------------------------------------------------------------------------------------------------------------------------------------------------------------------------------------------------------------------------------------------------------------------------------------------------------------------------------------------------------------------------------------------------------------------------------------------------------------------------------------

1.2.4 Waste disposal

	<ul style="list-style-type: none"> ● Do not dispose of the inverter together with household waste. The user has the responsibility and obligation to send it to the designated organization for recycling and disposal.
------------------------------------------------------------------------------------	----------------------------------------------------------------------------------------------------------------------------------------------------------------------------------------------------------------------------------------

2 Product overview

This chapter mainly describes the appearance, package accessories, nameplate and technical parameters of the grid-tied inverter.

2.1 Grid-tied PV power generation system

Grid-tied PV power generation system comprises solar panels, grid-tied inverter, energy meter and power grid.

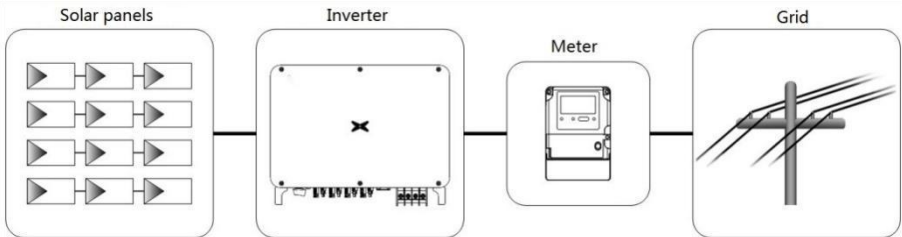

Fig 2.1 Application of grid-tied PV inverter

The grid-tied PV inverter is the core part of solar grid-tied PV power generation system. The sunlight can be converted through PV panel to DC power, which further converted by grid-tied inverter to the sine AC current with the same frequency and phase position as the public grid, then feedback the AC power to the grid.



- It is recommended that the PV array to be installed conforms to IEC 61730 class A standards.

2.1.1 Supported grid connection structure

iMars series grid-tied solar inverters support TN-S, TN-C, TN-C-S, TT and IT grid connection. When applied to the TT connection, the N-to-PE voltage should be less than 30V.

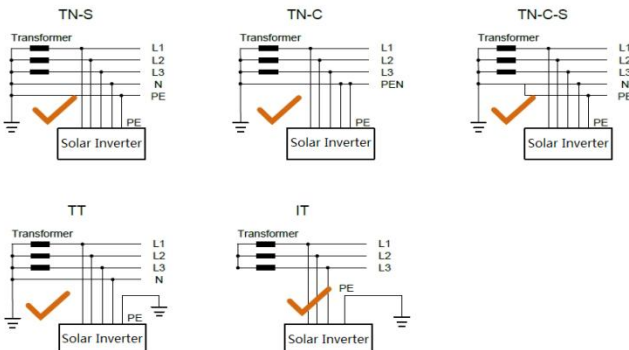

Fig 2.2 Type of grid

2.2 Product appearance

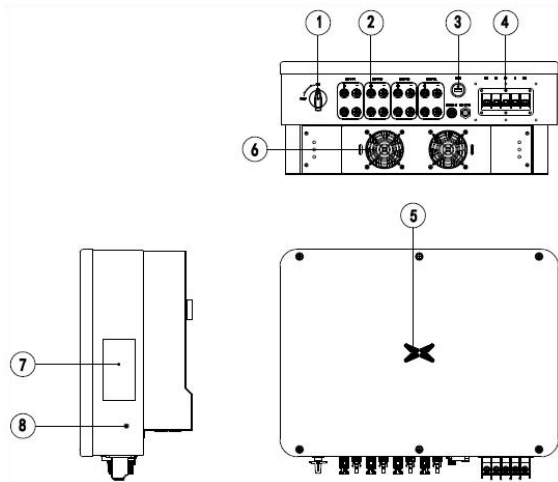

Fig 2.3 Appearance of the three-phase PV inverter

Table 2-1 Instruction list

No	Name	Instructions
1	DC switch	Switch on or off DC input
2	DC input connectors	DC input port, connect to PV array
3	Communication interfaces	USB, RS485, DRM communication terminals
4	AC connector	AC output port, connect to power grid
5	LED indicator	Indicates the working state of the inverter
6	Fan	Air inlet
7	Nameplate	Indicates the rated parameters
8	Earthing terminals	Two nos, connect at least one of them

2.3 Nameplate

Figure 2.4 shows the inverter nameplate.





invt		Grid-tied Solar Inverter	1
iMars XG40KTR			
DC Input			
Vmax. PV	1100V		
MPPT Range	200V-1000V		
Max. Current	26A/26A/26A/26A		
Isc PV	32A/32A/32A/32A		
AC Output			
Nominal Voltage	3/N/PE,230/400V		
Max. Current	64.3A		
Rated Power	40000W		
Max. Output Power	44000VA		
Frequency	50Hz/60Hz		
Power factor range	0.80un ~ 0.80ov		
Environment			
Temperature	-30°C ~ +60°C		
Protective Class	I		
Inverter topology	Non-isolated		
Ingress protection	IP66		
			
<div style="border: 1px dashed black; width: 100px; height: 20px; margin: 0 auto;"></div>			
Made in China			
INVT Solar Technology (Shenzhen) Co.,Ltd.			
2			
3			

Fig 2.4 Inverter nameplate

(1) Trademark and product type

(2) Model and important technical parameters

(3) Certification systems which the inverter conforms, serial number, company name and country of origin

Icons	Instruction
	<ul style="list-style-type: none"> TUV certification mark. The inverter is certified by TUV.
	<ul style="list-style-type: none"> CE certification mark. The inverter complies with the CE directive.
	<ul style="list-style-type: none"> CQC certification mark. The inverter passed CQC certification.
	<ul style="list-style-type: none"> EU WEEE mark. The inverter cannot be disposed of as domestic waste.

2.4 Product model

Table 2-2 Models of three-phase grid-tied PV inverter

Product name	Model	Rated output power(W)
three-phase (L1, L2, L3, N, PE)		
three-phase grid-tied solar inverter	XG25KTR-3M	25
three-phase grid-tied solar inverter	XG30KTR	30
three-phase grid-tied solar inverter	XG33KTR	33
three-phase grid-tied solar inverter	XG36KTR	36
three-phase grid-tied solar inverter	XG40KTR	40
three-phase grid-tied solar inverter	XG25KTR-3S	25
three-phase grid-tied solar inverter	XG30KTR-S	30
three-phase grid-tied solar inverter	XG33KTR-S	33
three-phase grid-tied solar inverter	XG36KTR-S	36
three-phase grid-tied solar inverter	XG40KTR-S	40

Note: Refer to the Appendix for technical parameters.

2.5 Outline dimension and weight

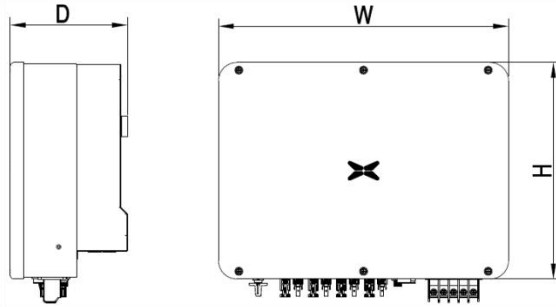

Fig 2.5 Dimensions of the inverter

Table 2-3 Dimensions and weight

Model	Height (mm)	Width (mm)	Depth (mm)	Net weight (kg)
25-40kW	425	570	230	37.5

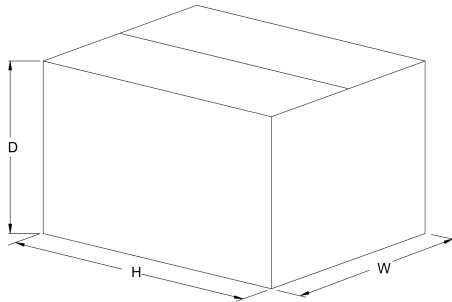

Fig 2.6 Dimension of carton box

Table 2-4 Package dimension and gross weight

Model	Height(mm)	Width(mm)	Depth(mm)	Weight(kg)	Package material
25-33kW	680	550	350	40	carton box
36-40kW	680	550	350	42	carton box



2.6 The front panel

The front panel comes with LED indicators (modern design) or LCD panel a to indicate the working state of the inverter.

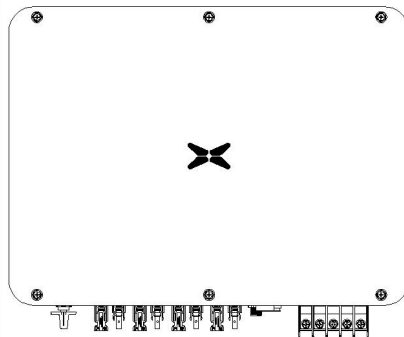
2.6.1 LED panel (Modern design)

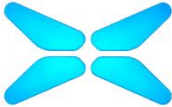

LED indication:

	Steady blue	Normal generating and on-grid status
	Blue blinking(5s)	DC or AC connected, inverter in standby or status (not yet power generating)
	Steady red	Error occurs.(The inverter fails to connect to the grid)
	Blue blinking(3s)	Alarm occurs.(The inverter is successfully connected to the grid)
	Off	DC and AC are disconnected

2.7 LCD display and operation

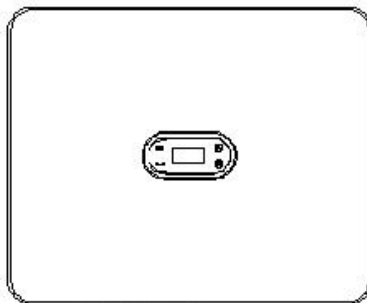

The LCD display shows the operating status of the inverter and various parameter information,

as well as setting the inverter parameters.



Screen button definition

Description	Up button	Downward button
Short press	Switch up or add 1 to the current number	Switch down or current number minus 1
Long press	Return to the previous level display or cancel	Go to the next level display or confirm

2.7.1 LED indicator definition and LCD display wake-up

(1) LED indicator definition

Run	Fault
Green light	Red light
Always on: Grid-connected status Blinking: Waiting status	Always on: Fault Blinking: Warning

(2) LCD display wake-up

When the LCD display detects the key operation, it automatically turns on the backlight and enters the display state; after 20 seconds of no operation, it automatically turns off the backlight and enters the hibernation mode.

2.7.2 Main screen display

The main interface dynamically displays inverter error information, operation information, and power generation information.

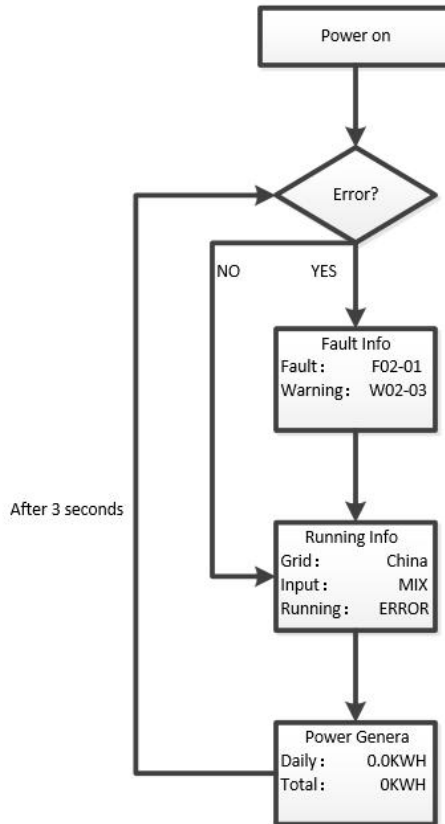

2.7.3 Menu screen display

Press and hold DOWN in the main screen to enter the menu screen, and then press and hold the key to enter the sub screen of each menu.

1.Basic information
2.Basic settings
3.Advanced options

2.7.4 Basic Information

After selecting the basic information, press and hold DOWN to enter the basic information menu, and go through the information in the sub screens by operating the buttons.

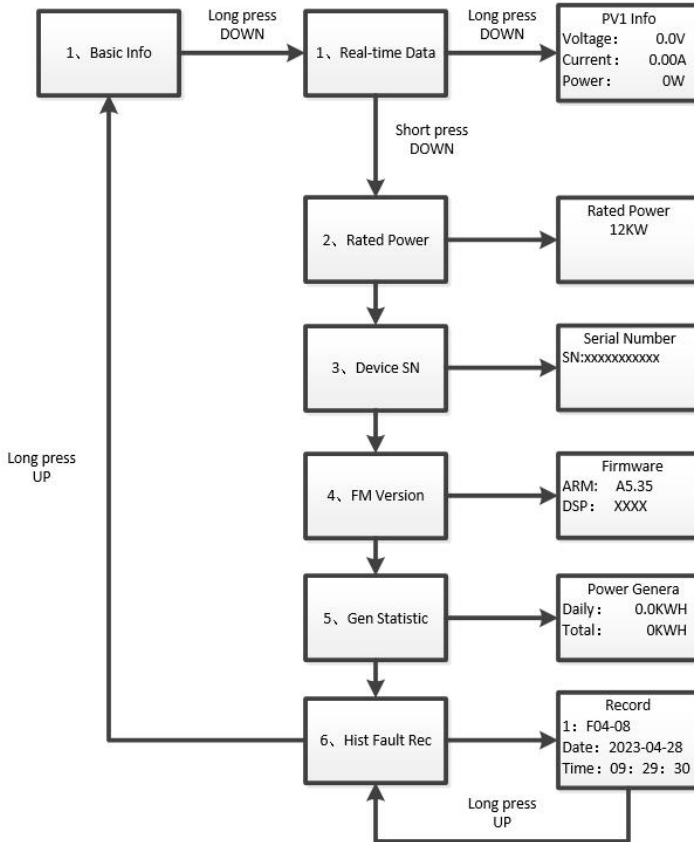

2.7.5 Basic Setting

After selecting basic settings, press and hold DOWN to enter the basic information menu, and view and set the parameters of the sub interface by operating the keys.

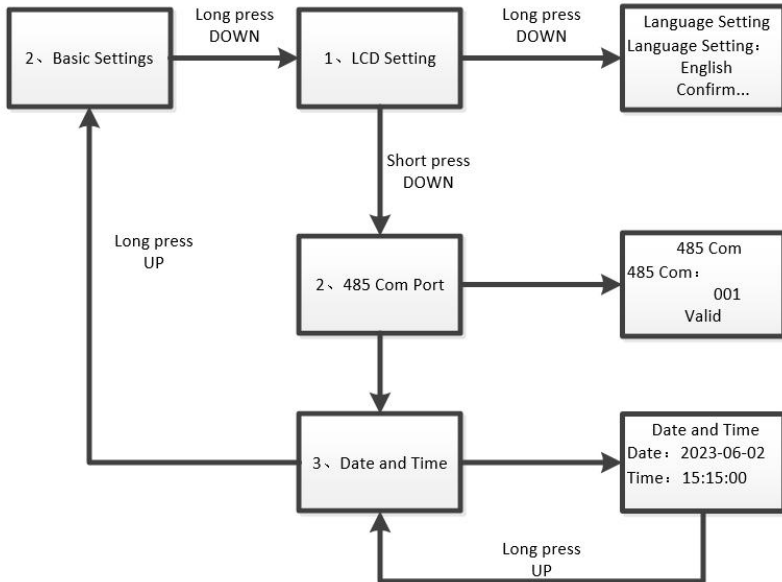

2.7.6 Advanced Options

After selecting the advanced option, press and hold DOWN to enter the basic information menu and view and set the parameters of the sub interface by operating the keys.

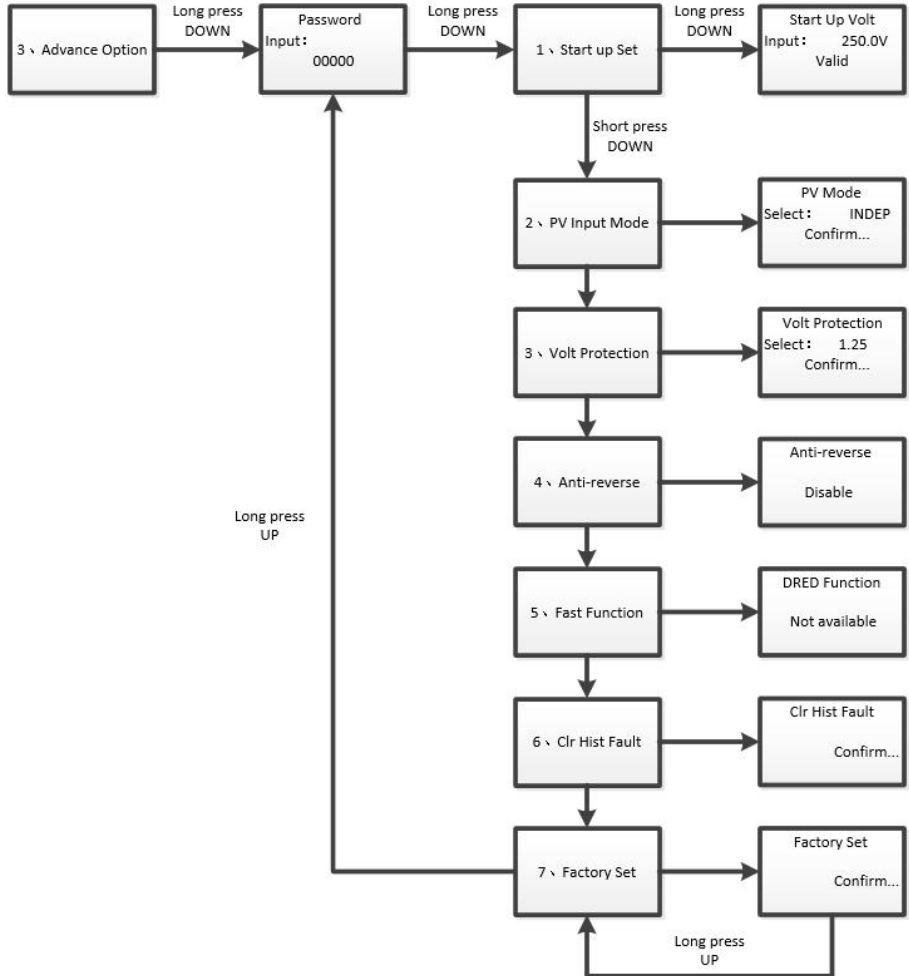

2.8 Bottom of chassis

XG25-40KTR is equipped with one DC switch, which connects or disconnects all PV inputs.

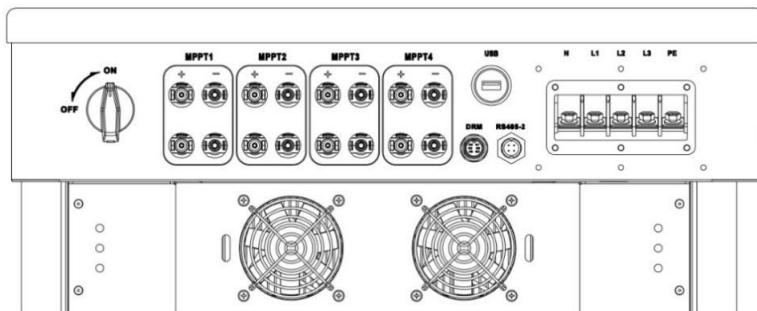

XG25-40KTR bottom view

3 Storage

If the inverter is not put into use immediately, the storage of inverter should meet the following requirements:

- Do not remove the outer packing.
- The inverter needs to be stored in a clean and dry place, and prevent the erosion of dust and water vapor.
- The storage temperature should be kept at $-30^{\circ}\text{C}\sim+70^{\circ}\text{C}$, and the relative humidity should be kept at 5%RH~95%RH.
- The stacking of inverters is recommended to be placed according to the number of stacking layers in the original shipment. Place the inverter carefully during stacking to avoid personal injury or equipment damage caused by the falling of equipment.
- Keep away from chemically corrosive substances that may corrode the inverter.
- Periodic inspections are required. If damages are made by worms and rats, or packaging is found damaged, the packaging materials must be replaced in time.
- After long-term storage, inverters need to be inspected and tested by qualified personnel before put into use.

4 Installation

This chapter describes how to install the inverter and connect it to the grid-tied solar system (including the connection between solar modules, public grid and inverter).

Read this chapter carefully and ensure all installation requirements are met before installation. Only qualified electricians are allowed to install the inverter.

4.1 Unpacking confirmation

The inverter has been thoroughly tested and rigorously checked before delivery, but damage may still occur during transportation. Before unpacking, check carefully whether the product information in the order is consistent with that on the nameplate of the package box and whether the product package is intact. If any damage is detected, please contact the shipping company or the supplier directly. Please also provide photos of the damage to get our fastest and best service.

Store the idled inverter in its original package and take anti-moisture and anti-dust measures.

After taking the inverter out of the box, check the following items:

Confirm the main body of the inverter is intact and free from any damage;

Confirm there is operation manual, interface accessories and installation accessories inside the package box;

Confirm the deliverables inside the package box are intact and complete;

Check whether the product information in the order is consistent with that on the inverter nameplate;

The standard delivery list is shown below.

Standard deliverables of three-phase inverter:

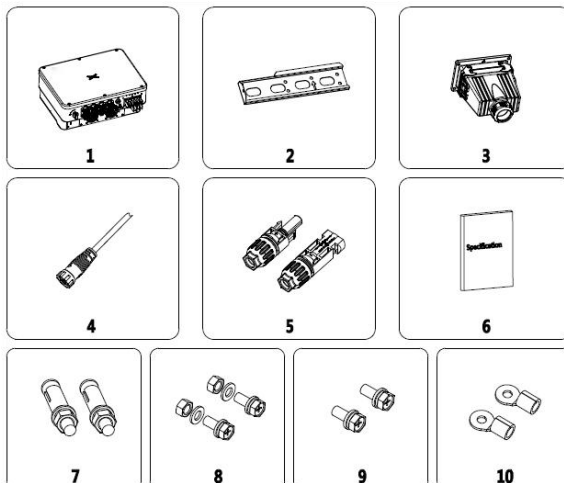

Fig 4.1 Deliverables of XG25-40KTR three-phase inverter

Table 4-1 Deliverables of three-phase inverter

No	Name	Qty
1	Inverter	1
2	Installation bracket	1
3	Water-proof cover for AC output	1
4	RS-485 communication cable	1
5	DC connector (pair)	6/8*
6	Operation manual	1
7	Expansion bolt (M8*60)	5
8	Nuts and bolts (M8)	5
9	Bolts (M4)	1
10	AC ring connector	5

*XG25KTR/XG30KTR/XG33KTR 6 pairs

* XG36KTR/XG40KTR 8 pair

Check above items carefully and if any question, contact the supplier immediately.

4.2 Preparation before installation

4.2.1 Installation tool

Table 4-2 List of installation tool

No	Installation tool	Purpose
1	Marker pen	Mark the installation hole
2	Electric drill	Drill holes on bracket or the wall
3	Hammer	Knock on the expansion bolt
4	Adjustable wrench	Fix the installation bracket
5	Inner hex screwdriver	Tighten the tamper-proof screw and disassemble AC junction box
6	“Slotted” or “cross-head” screwdriver	AC wiring
7	Mega ohmmeter	Measure the insulation and grounding impedance
8	Multi-meter	Check the circuit and measure AC/DC voltage
9	Electric soldering iron	Solder the communication cable
10	Wire crimper	Crimp DC terminal
11	Hydraulic clamp	Crimp ring connector for AC wiring

4.2.2 Installation environment

- (1) The inverter can be installed in indoor and outdoor environment.
- (2) During the operation of the inverter, the temperature of the chassis and heat sink will be relatively high. Please do not install the inverter in the easily touched position.
- (3) Do not install inverters in areas where flammable and explosive materials are stored
- (4) The inverter shall be installed in a place which has good ventilation to ensure good heat dissipation
- (5) It is recommended to choose the installation site with shelter or build sunshade.

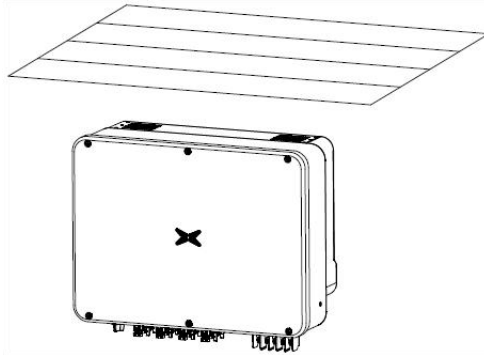

Fig 4.2 sunshade

- (6) The installation environment temperature is - 30 °C ~ 60 °C;
- (7) The installation site should be far away from the electronic equipment with strong electromagnetic interference;
- (8) The installation site should be fixed and solid object surface, such as wall, metal support, etc;
- (9) The installation position shall ensure the reliable grounding of the inverter, and the grounding metal conductor material shall be consistent with the reserved grounding metal material of the inverter.

4.3 Space requirements

- (1) Recommend to install the inverter to the height of eye level to check the inverter state conveniently.

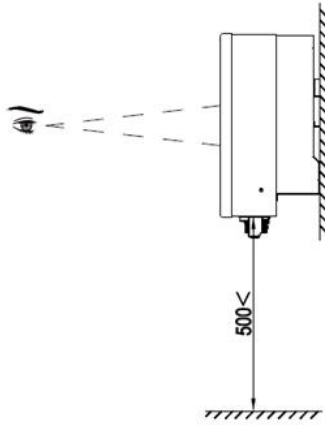

Fig 4.3 optimal installation height

(2) Make sure there is enough space for installation and ventilation, see below recommendations.

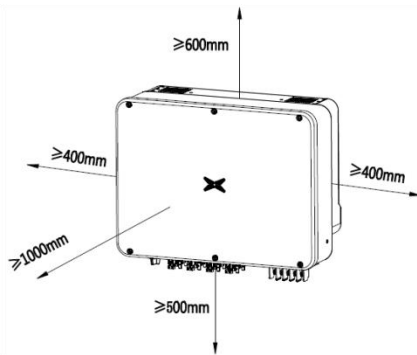

Fig 4.4 installation spacing of inverter

(3) When installing multiple inverters, a certain distance should be reserved between the inverters, as shown in Figure 4.4. At the same time, sufficient distance should be reserved between the upper and lower parts of the inverter to ensure good heat dissipation.

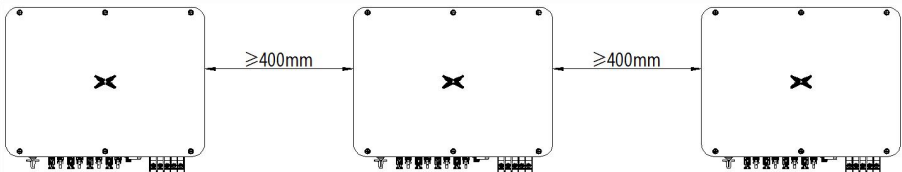

Fig 4.5 side by side installation spacing requirements

(4) Install the inverter vertically or lay back a little bit ($\leq 15^\circ$) for good heat dissipation. Do not tilt the inverter forward, horizontally, upside down, over-backward or roll it.

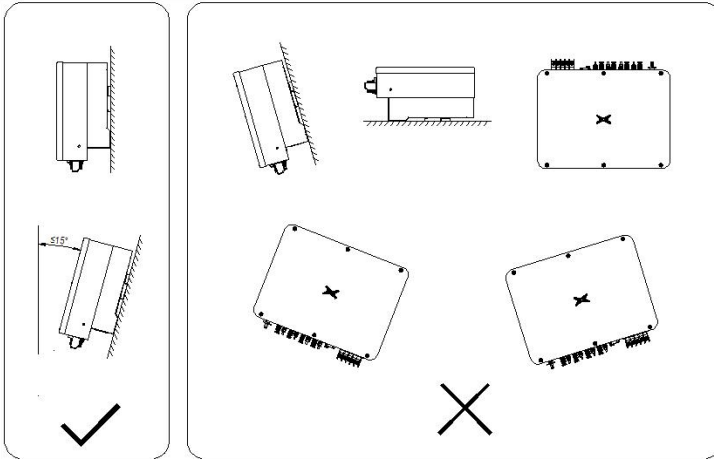

Fig 4.6 installation posture of inverter

4.4 Dimensions of the mounting bracket

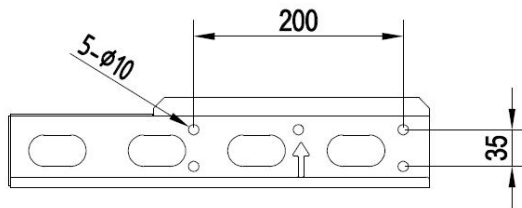
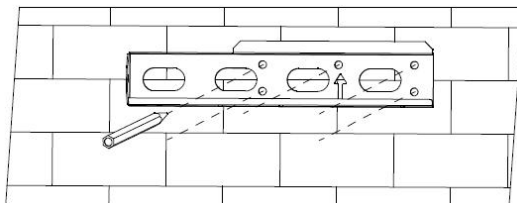

Fig 4.6 dimensions of mounting bracket

4.5 Wall installation

Step 1: Put the brackets onto the wall and adjust the horizontal level using the level meter, mark the bolt positions with marker pen.



Step 2: Drill holes on the wall for the M8 x 60 expansion bolts with impact drill.

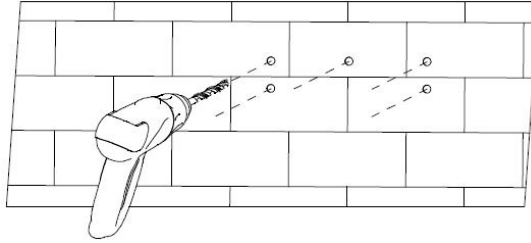

Step 3: Clean the dust out from the holes and knock the screw and expansion tube of the expansion bolts into the holes with a rubber hammer. Put the bracket, flat pads, spring pads and nuts in turn onto the bolts. Tighten the nuts with 13N•m.

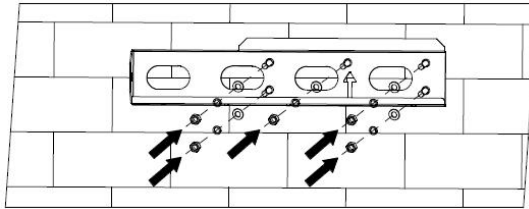

4.6 Installation of inverter

Step 1: Take the inverter out of the packing box.

Step 2: If the installation position is high, it is necessary to use lifting machine to lift the inverter. Lift the inverter 100 mm up from the ground and pause, double check if everything is tight and the lifting is safe.

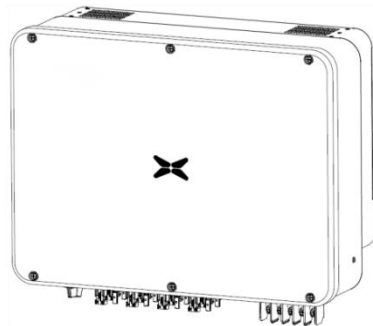

Step 3: Hang the inverter onto the bracket and make sure the hanging is in place.

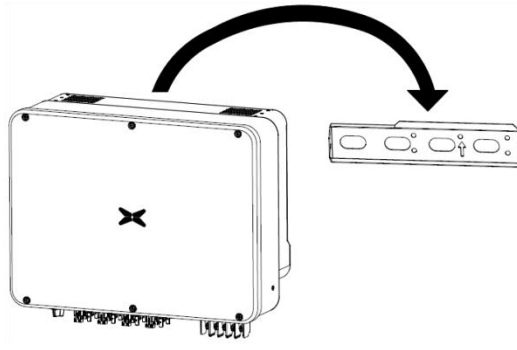

Step 4: Fix the inverter and the bracket with one M4 x 12 screw on the left side of the inverter with 2.5N•m, see below.

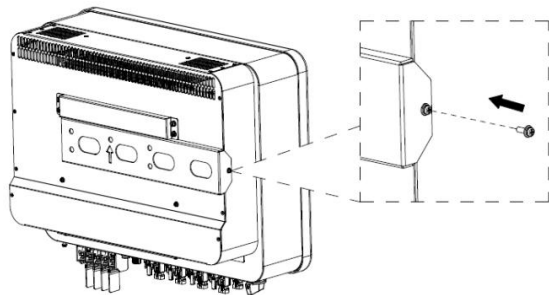

5 Electrical connection

5.1 Overview of electrical connection

This section presents the detailed contents and safety precautions related to electrical connection.

Fig 5.1 is the connection diagram for Grid-tied PV system.

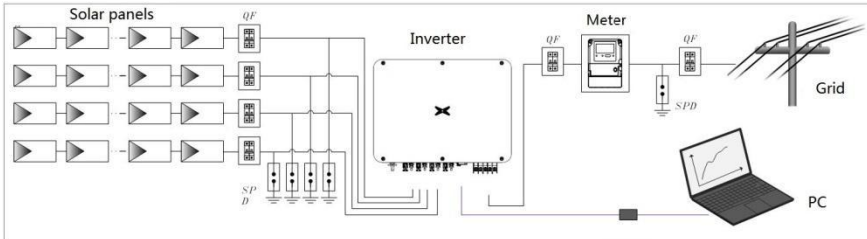



Fig 5.1 Connection diagram of the Grid-tied PV system

	<ul style="list-style-type: none"> ● Electrical connection must be carried out by professional technicians as wrong operation may cause damage to the device, physical injuries or even death during system operation. ● All the electrical installation must conform with the national regulations concerning electrical safety regulations. ● Ensure all the cables are installed firmly according to the specified safety requirements and free from any damage. ● It is not allowed to turn on the AC and DC breakers before all cable connections are finished and checked.
Note	<ul style="list-style-type: none"> ● Read this section carefully and operate strictly according to the requirements. ● Note the rated voltage and current specified in the manual as they cannot be exceeded.

5.2 Connect the protective earth wire

Step 1: Crimp OT terminal on the ground wire.

Step 2: Fix the ground wire on the right side of the inverter with 4-5 N·m, see below

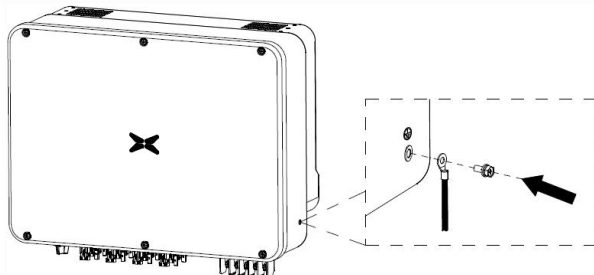

5.3 Connection of solar string

Step 1: Make MC4 connectors for each PV string

MC4 crimping method:

(1) Remove 8-10mm cable sheath from the PV cable (see A and B below), crimp the inner contact of MC4 connector with the cable(see C below, the longer one is for positive PV wire);

Take off the nuts of the MC4 and insert the crimped cables through the nuts (see D and E below, the D is for the positive wire);

Tighten the nuts with 2.5-3 N·m (see F below)

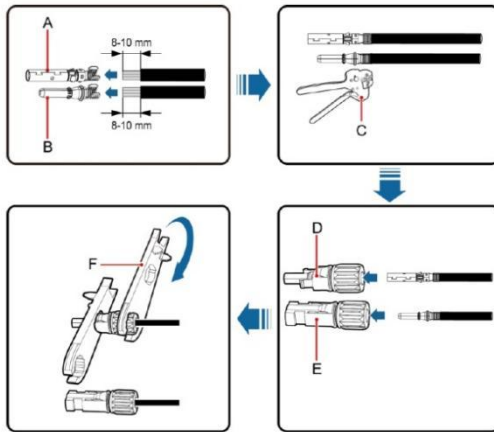

Fig 5.2 MC4 connector making

(2) Verify the polarity of the MC4 connector, make sure they are correct (see Fig 5.3). Check if the voltage of the PV string is within what's expected. Make sure to check each PV string.

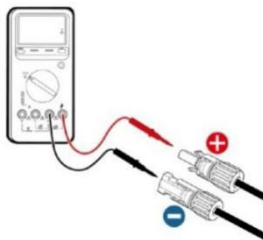
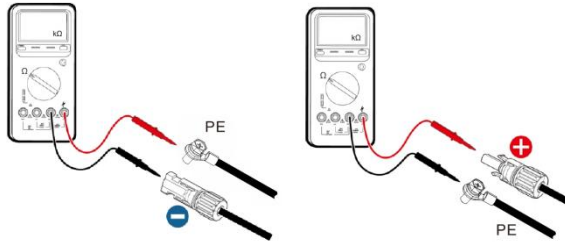

Fig 5.3 DC input polarity and voltage check

(3) After the DC connector is connected, you need to use a multimeter or megohmmeter to measure the insulation of the positive and negative terminals of each string to the ground, and the insulation is normal before you can access the inverter.



a. Check the PV+ ground insulation impedance value of the PV series to ensure that the impedance value of each series is greater than 1 MΩ.

b. Check the PV-to-ground insulation impedance value of the PV series to ensure that the impedance value of each series is above 1MΩ.



- Use the DC connectors delivered along with the inverter, do not use other connectors without authorization from our company, otherwise damage to the device, unstable operation or fire may occur and our company will not undertake quality assurance or assume any direct or joint liability thereof.

Step 2: Connect the MC4 connectors to the inverter, Make sure to distinguish each pair of PV string.

- (1) Connect the MC4 connectors to the inverter, you will hear the 'click' sound;
- (2) To disconnect the MC4 connection, use MC4 spanner as below and unplug;

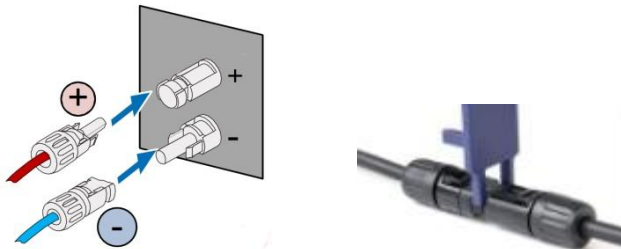

Fig 5.4 Connect and disconnect PV string connection

5.4 DRM & RS485 terminal connection

DRM & RS485 terminals are shown in the following figure:

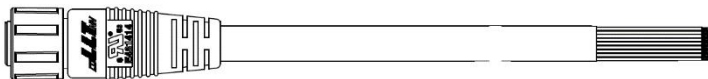

Figure 5.5 Side view of DRM & RS485 terminal

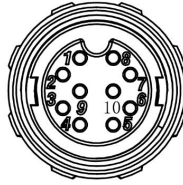



Figure 5.6 Front view of DRM & RS485 terminal

Table 5-1 DRM & RS485 terminal signal description

Pin Foot No.	Wire color	Signal Name
1	Red	RS485-
2	Brown	RS485+
3	Yellow	Dry contact-
4	Green	Dry contact+
5	White	COM
6	Blue	REF
7	Black	DRM4/8
8	Orange	DRM3/7
9	Purple	DRM2/6
10	Grey	DRM1/5

5.5 Three-phase inverter grid connection

Table 5-1 Interface description of three phase solar inverter AC connector

Inverter AC connector interface	Three phase grid	remarks
L1	L1 (A)	
L2	L2 (B)	
L3	L3 (C)	
N	N(Neutral line)	
	PE (ground wire)	Must be connected

5.5.1 Cable specifications

In order to standardize and be compatible with the specifications of AC / DC connectors or terminals of inverters, the following requirements are made for AC / DC cables connecting corresponding models of inverters:

Table5- 2 Cable specifications

Model	DC side	AC side
	Recommended min. Cross-section mm ² (length ≤ 50m)	Recommended min. cross-section mm ² (length ≤ 50m)
XG25-33KTR	4-6	16-35
XG36-40KTR	4-6	25-50

Remarks: DC cable: meet the standard 1100V PV cable;

AC cable: outdoor 4 / 5 core copper wire / aluminum core wire;

5.5.2 Grid connection

(1) Crimp ring connectors on the AC cable for the Grid, the N of the five cores (L1, L2, L3, N, PE) is optional. It is very important that the crimping is tight and reliable;

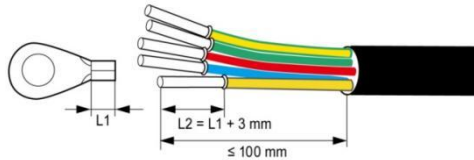

Fig 5.5 crimping cable terminals

(2) Connect the crimped AC cable to the AC block of the inverter with 7-9N·m (PE) and connect the AC water-proof cover.

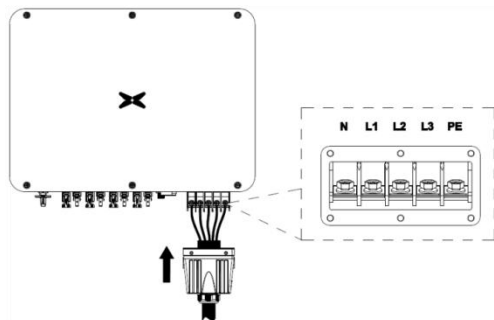

Fig 5.6 AC connection

(3) Lock the AC water-proof cover on the left and right, see below.

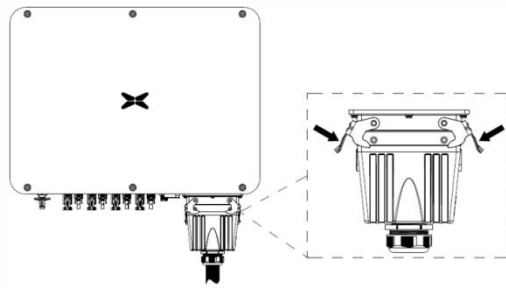
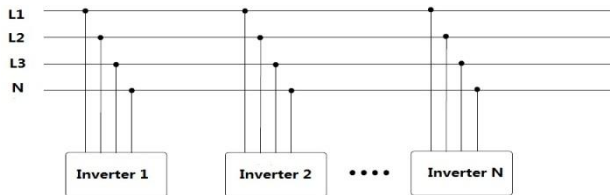

Fig 5.7 AC water-proof cover lock

5.5.3 Parallel operation requirements

Multiple inverters can be connected to the low-voltage three-phase grid directly, contact us if the total capacity of the inverters exceeds 0.5-0.8MVA.



If the Grid is not low-voltage, a step-up transformer should be used. Connect the inverters to the low voltage side of transformer. The transformer used should have capacity higher than the total capacity of the inverters. The transformer should have neutral point.

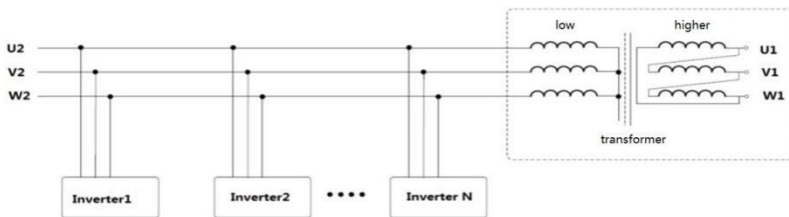

	<ul style="list-style-type: none"> ● It is recommended to use the transformer of which the short-circuit impedance is no more than 7%
--	------------------------------------------------------------------------------------------------------------------------------------------------------

6 Running

This chapter mainly introduces inverter operations related to inspection before running, power generation, stop power generation and maintenance.

6.1 Inspection before running

The following items must be checked strictly before running the Grid-tied PV inverter (including but not limited to the following items):

- (1) Confirm the installation site of the inverter meet requirements of section 4.2.2 to ensure convenient installation, disassemble, operation and inspection on the inverter;
- (2) Confirm the mechanical installation of the inverter meet requirements of section 4.3;
- (3) Confirm the electrical connection of the inverter meet the requirements of section 4.4;
- (4) Confirm all the switches are in “OFF” state;
- (5) Confirm the open-circuit voltage of each PV string conforms to the parameter requirements of inverter DC ratings, the ratings can be checked in the Appendix;
- (6) Confirm the electrical safety marks on the installation site is clear enough.



- In order to ensure a safe, normal and stable operation of the PV power generation system, all the newly installed, renovated and repaired Grid-tied PV power generation system and its grid-tied inverter must undergo inspection before running.

6.2 Inverter grid-tied running

Start the inverter according to below steps to achieve grid-tied operation of the inverter:

Note

- The Grid standard must be set for the initial setup, set the Grid standard according to the your national standard, see section 6.5
- Keep the inverter power on for at least 30 minutes to charge the built-in clock battery of the inverter to ensure the clock can run normally!

- (1) Confirm the requirements in section 6.1 are fulfilled;
- (2) Switch on the AC breaker to connect the inverter to the Grid;
- (3) Switch on the built-in DC switch of the inverter;
- (4) Switch on the external DC switch to connect the PV strings to the inverter;
- (5) Observe the LED indicator state of the inverter (For details, please see 2.6.1 and 2.6.2 LED indications)



Run Green running LED blinks (the other two LEDs are off): Inverter powered on and self-checking, waiting for enough solar power for generation;

- Run Running LED is solid green (the other two LEDs are off): Inverter self-checking passed, generation power to the Grid.

'Alarm' or 'Fault' is on or blinks: Inverter powered on but has errors. Check on the LCD and look up the codes on Table 8-1 for the definition of the codes. To troubleshoot, stop the inverter first (refer to section 6.3) and refer to section 8 for troubleshooting. Upon all faults are cleared, refer to section 5 to connecting the inverter back to the system.

- (6) Refer to section 6.4.4 to set the Day and time according to your local time.
- (7) Refer to section 6.4.4 to set the DC input mode. The default DC input mode is 'Independent'

mode.

6.3 Inverter stop

When it is necessary to carry out power-off maintenance, inspection and fault elimination on the inverter, stop the inverter according to the following steps:

- (1) Disconnect the AC breaker to disconnect the Grid from the inverter;
- (2) Disconnect the built-in DC switch of the inverter;
- (3) Disconnect the external DC breaker to disconnect PV strings;
- (4) Before trying to take off or open the inverter, wait for at least 5 minutes until the internal parts of the inverter are fully discharged.

6.4 Regular inspection and maintenance

The inverter can run in all seasons, it starts and stops power generation automatically, but to ensure system stability and extend inverter life span, it is necessary to perform regular inspection and maintenance according to the manual.

6.4.1 Regular inspection and maintenance list

Inspection item	Inspection method	Maintenance cycle
Inverter running data	Backup the running data, parameters and logs on the monitoring software.	Once per quarter
Inverter running state	Check if the inverter is hung reliably, has visible dent or deformed. Check if there is abnormal running noise in the inverter. Check if running data makes sense. Check if the housing is too hot with thermal camera.	Once per half a year
Clean the inverter	Check the ambient humidity and dust, refer to section 6.4.2 to clean the inverter when necessary.	Once per half a year
Electrical connection	Check if the electrical connection is loose, refer to corresponding section to tighten the connection if necessary. Check if the cable sheath has visible damage,	Once per half a year

Inspection item	Inspection method	Maintenance cycle
	especially where it is close to the metal.	
Cooling fan	Check if the air intake and exhaust are normal, check if the fan has abnormal running noise and if its blades have cracks. Clean the air inlet if necessary. Refer to corresponding section to change the fan if necessary.	Once per half a year
Safety function	Stop power generation on the LCD to verify the function, check the communication under such condition. Check if the warning sign is complete and clear, change it if necessary.	Once per half a year

6.4.2 Maintenance guidance

Clean the inverter

The cleaning steps are listed below:

- (1) Disconnect the AC and DC connection;
- (2) Wait for ten minutes;
- (3) Clean the surface and air inlet/outlet of the inverter with soft brush or vacuum cleaner;
- (4) Repeat the operations in section 6.1;
- (5) Restart the inverter.

Fan maintenance



- Disconnect AC and DC connections of the inverter to stop the inverter before maintenance.
- After AC and DC are disconnected, wait for at least 5 minutes until the internal capacitors of the inverter are fully discharged before maintenance.
- The fan can be maintained and replaced by professional electricians only.

Step 1: Stop the inverter running and disconnect the electrical connections.

- (1) Disconnect the DC input and AC output circuit breakers.
- (2) Turn the built-in DC switch to the "OFF" position.
- (3) Wait at least 10 minutes.
- (4) Disconnect all cable connections from the bottom of the inverter.

Step 2: Unscrew the screws as below, unplug the fan cables and remove the fan plate at the bottom.

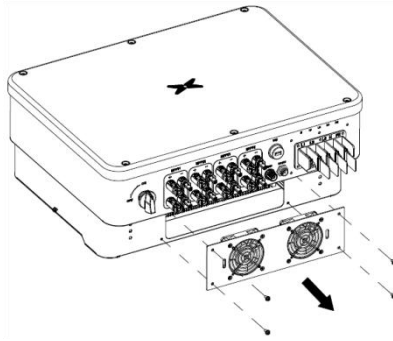

Step 3: Clean the fan with dusting brush or vacuum cleaner, change it if the fan has been damaged (refer to below Step 4).

Step 4: If the fan has been damaged, refer to below picture to change it with a new one.

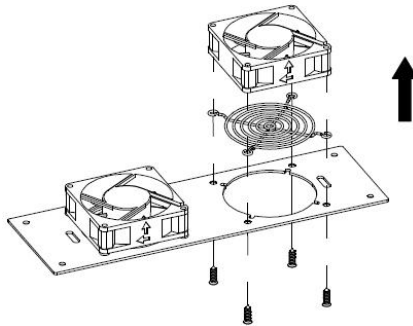

Step 5: Install the fan plate back to the bottom of the inverter and connect all the cables back and make sure all connections are tight and reliable, restart the inverter.

Note	<ul style="list-style-type: none"> Once the inverter stops due to an alarm, it is forbidden to start the machine immediately. The cause should be identified and all faults must be eliminated before starting up. Inspections should be carried out in strict accordance with the procedures in Section 6.1
-------------	-----------------------------------------------------------------------------------------------------------------------------------------------------------------------------------------------------------------------------------------------------------------------------------------------------------------------------

7 Troubleshooting

This chapter describes the error codes for fast troubleshooting.

Table 8-1 Inverter error codes

Code	Descriptions (short)	Descriptions (long)	Troubleshooting tips
A			
A001	Input UV	Input under-voltage	PV under-voltage
A002	Bus UV	Bus under-voltage	PV under-voltage or boost circuit fail
A003	Grid UV	Grid under-voltage	Grid voltage is too low
A004	Grid OV	Grid over-voltage	Grid voltage is too high
A005	Grid UF	Grid under-frequency	Grid frequency is too low
A006	Grid OF	Grid over-frequency	Grid frequency is too high
A007	Clock Fail	Clock fail	Wrong time set on the clock
A009	Cmd Shut	Manual off	Inverter has been manually turn off (via handheld HMI or supervisory computer)
A011	Grid Loss	Grid lost	Check if the AC is connected (e.g., check if AC breaker is connected) or the Grid has normal voltage
E			
E001	Input OV	Input over-voltage	PV input voltage is too high
E003	Bus OV	Bus over-voltage	Inverter internal bus voltage is too high
E004	Boost Fail	Boost fail	Inverter boost circuit fail
E005	Grid OC	Grid over-current	Inverter AC output current is too high
E006	OTP	Over temperature protection	Inverter internal temperature is too high
E007	Riso Low	Isolation resistance is too low	Isolation resistance is too low
E008	IGBT drv	IGBT driver protected	Inverter IGBT driver protection is triggered
E009	IntComm	Internal	The internal main and aux DSPs

Code	Descriptions (short)	Descriptions (long)	Troubleshooting tips
		communication error	cannot communicate with each other or the data check failed
E010	ILeak Fail	Leakage current is too high	System/inverter leakage current is too high
E011	Relay Fault	Relay fault	Inverter internal relay has fault
E012	Fan Fail	Fan fail	Inverter fan has fault
E013	Eeprom	Memory abnormal	Inverter internal memory has fault
E014	Dc inject	DC component is too much	DC component is too much in the AC output
E015	OutputShort	Output short circuit	AC output short circuit
E018	Input OC	Input over-current	Input over-current
E019	Incnst	Data inconsistent	The sample data is inconsistent between the main and aux DSPs
E020	PowerReversed	DC power reversed	DC power reversed

If any problem, please contact with the supplier and provide following information:

- Model of the inverter: _____;
- Serial No. of the inverter: _____;
- System version:
 - version 1: _____;
 - version 2: _____;
 - MCU software version: _____;
- Fault code: _____;
- Fault description _____

8 Contact us

China·Shenzhen

INVT Solar Technology (Shenzhen) Co., Ltd.

Address: 6th Floor, Block A, INVT Guangming Technology Building, Songbai Road, Matian,
Guangming District, Shenzhen, China

Service hotline: +86 400 700 999

E-mail: solar-service@invt.com.cn

INVT group website: www.invt.com

INVT solar website: www.invt-solar.com

9 Appendix

Table 9-1 Datasheet

Model		XG25KTR-3M	XG30KTR	XG33KTR	XG36KTR	XG40KTR
DC	Max. DC voltage (V)	1100	1100	1100	1100	1100
	Start-up voltage (V)	250	250	250	250	250
	MPPT voltage range (V)	200~1000	200~1000	200~1000	200~1000	200~1000
	DC voltage range during rated output power (V)	450-800V	500-800V	500-800V	500-800V	500-800V
	MPPT number/ PV string number per MPPT	3/2	3/2	3/2	4/2	4/2
	Max. PV array power (W)	40000	48000	52800	57600	64000
	Max. input current each MPPT (A) x MPPT number	26x3	26x3	26x3	26x4	26x4
Max. Isc (short-circuit current) of the PV array within each MPPT (A)	32	32	32	32	32	
AC	Rated output power (W)	25000	30000	33000	36000	40000
	Rated voltage and frequency range (V)	230/400Vac,3L+N+PE/3L+PE,50/60Hz±5HZ (adjustable)				
	Rated AC output current (A)	36.2	43.5	47.8	52.2	57.9
	Max. AC output current (A)	40.1	48.3	53	57.8	64.3
	Power factor	-0.8~+0.8 (adjustable)				
THDi	< 3% (@Rated power)					
System	Cooling method	Smart fan				
	Max. efficiency	98.60%				
	European efficiency	98.20%				
	MPPT efficiency	99.90%				
	Ingress protection	IP66				
	Power consumption at night	< 1W				
	Protective class	I				
	Overvoltage protection class	AC:III,PV:II				
	Inverter topology	Non-isolated				
	Pollution degree	3				
	Operating temperature	(-30℃~+60℃), auto derating is required if the ambient temperature exceeds 45℃				
	Humidity	RH 0~100%,condensation				
	Max. altitude (m)	≤4000, derating is required if the altitude exceeds 3000m				
	Display	LED, Bluetooth + APP				
	System language	English, Chinese, Germany, Dutch				
	Communication	RS485 (standard) /WiFi (optional) /4G (optional) /GPRS (optional)				
	DC terminal	MC4 water-proof connector				
Installation	Wall mount					
Protections	Input overvoltage protection, input overcurrent protection, DC insulation monitoring, DC monitoring, grounding fault current monitoring, grid monitoring, islanding protection, short-circuit protection and overheat protection, etc.					

Table 9-2 Datasheet

Model		XG25KTR-3S	XG30KTR-S	XG33KTR-S	XG36KTR-S	XG40KTR-S
DC	Max. DC voltage (V)	1100	1100	1100	1100	1100
	Start-up voltage (V)	250	250	250	250	250
	MPPT voltage range (V)	200~1000	200~1000	200~1000	200~1000	200~1000
	DC voltage range during rated output power (V)	500-800V	500-800V	500-800V	500-800V	500-800V
	MPPT number/ PV string number per MPPT	3/1	3/1	3/1	4/1	4/1
	Max. PV array power (W)	48000	52800	57600	64000	64000
	Max. input current each MPPT (A) x MPPT number	16x3	16x3	16x3	16x4	16x4
Max. Isc (short-circuit current) of the PV array within each MPPT (A)	20	20	20	20	20	
AC	Rated output power (W)	25000	30000	33000	36000	40000
	Rated voltage and frequency range (V)	230/400Vac,3L+N+PE/3L+PE,50/60Hz±5HZ (adjustable)				
	Rated AC output current (A)	36.2	43.5	47.8	52.2	57.9
	Max. AC output current (A)	40.1	48.3	53	57.8	64.3
	Power factor	-0.8→+0.8 (adjustable)				
THDi	230/400Vac,3L+N+PE/3L+PE,50/60Hz±5HZ (adjustable)					
System	Cooling method	Smart fan				
	Max. efficiency	98.60%				
	European efficiency	98.20%				
	MPPT efficiency	99.90%				
	Ingress protection	IP66				
	Power consumption at night	< 1W				
	Protective class	I				
	Overvoltage protection class	AC:III,PV:II				
	Inverter topology	Non-isolated				
	Pollution degree	3				
	Operating temperature	(-30℃~+60℃), auto derating is required if the ambient temperature exceeds 45℃				
	Humidity	RH 0~100%,condensation				
	Max. altitude (m)	≤4000, derating is required if the altitude exceeds 3000m				
	Display	LED, Bluetooth + APP				
	System language	English, Chinese, Germany, Dutch				
	Communication	RS485 (standard) /WiFi (optional) /4G (optional) /GPRS (optional)				
DC terminal	MC4 water-proof connector					
Installation	Wall mount					
Protections	Input overvoltage protection, input overcurrent protection, DC insulation monitoring, DC monitoring, grounding fault current monitoring, grid monitoring, islanding protection, short-circuit protection and overheat protection, etc.					



Service Hotline: +86 400 700 9997 Email: solar-service@invt.com.cn website: www.invt-solar.com

INVT Solar Technology (Shenzhen) Co., Ltd.

6th Floor, Block A, INVT Guangming Technology Building, Songbai Road, Matian, Guangming District, Shenzhen, China