



# INVT User Manual

## Hybrid Inverter

### XD3K~6KTL-AIO



**深圳市英威腾光伏科技有限公司**  
INVT Solar Technology (Shenzhen) Co., Ltd

## Contents

Chapter 1	Introduction .....	1
Chapter 2	Safety Precautions .....	2
2.1	Safety Symbols .....	2
2.2	Precautions for Operation .....	2
Chapter 3	Product Introduction .....	4
3.1	Intended User .....	4
3.2	Product Overview .....	4
3.3	Safety Instructions .....	5
3.4	Schematic Diagram of the Basic System .....	6
3.5	Product Features .....	6
Chapter 4	Installation .....	7
4.1	Unpacking Inspection .....	7
4.2	Before installation .....	8
4.3	Space Requirements .....	9
4.4	Inverter Dimension and Weight .....	11
4.5	Drilling .....	11
4.6	Battery Base Installation .....	12
4.7	Battery Placement .....	12
4.8	Installation of Inverter .....	14
Chapter 5	Electrical Connection .....	15
5.1	Electrical Connection Overview .....	15
5.2	Battery-to-Battery and Battery-to-Inverter Power & Communication Wiring .....	17
5.3	Side Panel Installation .....	17
5.4	PV Wiring .....	18
5.5	AC Wiring .....	18
5.6	CT Connection .....	19
5.7	Connection of Smart Meter .....	20
5.8	Connection of Grounding Wire .....	21
5.9	Parallel Connection Wiring .....	21
Chapter 6	Commissioning .....	23
6.1	Startup .....	23
6.2	Shutdown .....	23
Chapter 7	Parameter Settings .....	24

---

7.1	Menu Information .....	24
7.2	"Setting Info" Page .....	29
Chapter 8	System Debugging .....	50
8.1	LCD Screen and Keys .....	50
8.2	Working Mode .....	52
8.3	Setting Parameters in Solarman App .....	53
Chapter 9	System Maintenance .....	54
9.1	Regular Maintenance of Inverter .....	54
9.2	Powering Off the Inverter .....	55
9.3	Removing the Inverter .....	55
9.4	Scrapping the Inverter .....	55
Chapter 10	Troubleshooting .....	56
Chapter 11	Product Specifications .....	63

## **Chapter 1    Introduction**

This Manual describes the specification, installation, operations and maintenance of INVT hybrid inverter.

Please read this Manual carefully to understand the safety information, functions and features of the product before installing and using it. The information provided in this Manual is subject to update from time to time due to product improvements. The latest version and more product information are available on our official website.

## Chapter 2 Safety Precautions

Improper use may result in risk of electric shock or burns. This Manual provides important instructions for installation and maintenance of the product. Please read this Manual carefully before using the product, and keep it for future reference.

### 2.1 Safety Symbols

The following are the safety symbols used in this Manual to indicate potential safety risks and important safety instructions.



**WARNING!**

The warning symbol indicates important safety information that, if not followed properly, could result in serious personal injury or even death.



**RISK OF ELECTRIC SHOCK!**

The electric shock hazard symbol indicates important safety information that, if not followed, could result in electric shock.



**SAFETY TIPS!**

This symbol indicates important safety information that, if not followed, could result in serious personal injury or even death.



**HIGH TEMPERATURE!**

This symbol indicates safety information that, if not strictly followed, could result in burns.



**WARNING!**

When performing maintenance on the input and output of the inverter after disconnecting it, wait at least 5 minutes for the inverter to discharge any remaining electrical charge.

### 2.2 Precautions for Operation

The hybrid inverter in XD3K-6KTL-AIO series has been designed and tested according to the applicable safety regulations. This ensures the personal safety of the user. However, as an electrical equipment, the inverter could cause electric shock or other injuries if not operated properly. Please operate the inverter in accordance with the following requirements:

1. The wiring, installation and commissioning work should be carried out by professionals.
2. Be sure to read this Manual before operating the product. We shall not be held liable for any failure or loss caused by improper operation.
3. Before starting the installation or maintenance work, please break the connections at the AC side, DC side

and battery side, and then wait at least 5 minutes before proceeding to avoid electric shock.

4. When the inverter is running, the temperature of the housing is high. Do not touch it to avoid getting burned.

5. All electrical installations must conform to local electrical standards. The inverter should be connected to the power grid by professionals with the permission of the local power provider.

6. During the installation, insulated tools and personal protective equipment should be used to ensure personal safety. To touch the electronic components of the inverter, please wear anti-static gloves, anti-static wrist strap or anti-static clothing so as to protect the inverter against electrostatic discharge.

7. Please install the inverter at a position that is out of the reach of children.

8. Do not plug or remove the AC/DC terminal during normal operation of the inverter.

9. The actual DC input voltage should not exceed the maximum allowable DC input voltage of the inverter.

10. Select an appropriate battery that matches the system, and set the battery type correctly. If you select a battery that does not match the hybrid inverter, the system cannot run.

11. If the battery has been completely discharged, please strictly follow the User Manual of the battery to charge the battery.

12. For system maintenance service, please contact our local authorized service personnel or our after-sales personnel.

13. The hybrid inverter system should be connected to the power grid after getting permission.

14. Turn off the PV switch before installing a solar PV panel during the sunny daytime, or there could be a serious risk of electric shock.

15. Do not connect a PV string to more than one inverter, as this could cause damage to the inverters.

16. Do not connect a device that relies on continuous and stable power supply (such as a life-sustaining medical device), to the emergency power supply (EPS) port.

## Chapter 3 Product Introduction

### 3.1 Intended User

The hybrid inverter in XD series should be installed only by trained professionals who are familiar with local regulations, standards and electrical systems and have a good knowledge of this product.

It is highly recommended that the installer read this Manual carefully, so as to learn about product installation, troubleshooting and communication networking.

### 3.2 Product Overview

The inverter in XD series is intended to store the energy generated in the PV system or provided by the public power grid into the battery, and also output energy to the power grid. In the case of electric power failure, the hybrid inverter can provide energy to the load as a backup power supply.

This Manual applies to the following hybrid inverter models:

XD3KTL-AIO\XD3K6TL-AIO\XD4KTL-AIO\XD4K6TL-AIO\XD5KTL-AIO\XD6KTL-AIO

Overview:

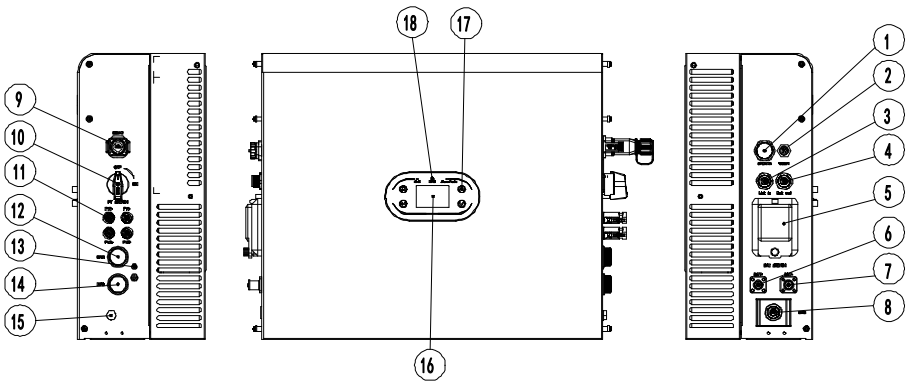

No.	Description	No.	Description
1	USB Port (Software Upgrade)	2	COM-1 (RS485 / Wi-Fi / GPRS communication)
3	Parallel RJ45 Input Interface	4	Parallel RJ45 Output Interface
5	Battery Switch	6	Positive Battery Interface
7	Negative Battery Interface	8	BMS Lithium Battery Communication
9	COM-2 (CT/DRM communication)	10	PV DC Switch

11	PV Input Terminal	12	Grid Terminal
13	GND (grounding point)	14	EPS Output Terminal
15	Breather Valve	16	LCD Screen
17	Function Keys	18	LED Indicator Light

### 3.3 Safety Instructions

1. Be sure to read this Manual before operating the product. We shall not be held liable for any failure or loss caused by improper operation.
2. Select an appropriate battery that matches the system, and set the battery type correctly. If you select a battery that does not match the hybrid inverter, the system cannot run.
3. If the battery has been completely discharged, please strictly follow the User Manual of the battery to charge the battery.
4. The wiring, installation and commissioning work should be carried out by professionals.
5. During the installation, insulated tools and personal protective equipment should be used to ensure personal safety. To touch the electronic components of the inverter, please wear anti-static gloves, anti-static wrist strap or anti-static clothing so as to protect the inverter against electrostatic discharge.
6. All electrical connections must comply with the safety regulations of the local power provider.
7. For system maintenance service, please contact our local authorized service personnel or our after-sales personnel.
8. The hybrid inverter system should be connected to the power grid after getting permission.
9. Turn off the PV switch before installing a solar PV panel during the sunny daytime, or there could be a serious risk of electric shock.
10. Do not connect a PV string to more than one inverter, as this could cause damage to the inverters.



### 3.4 Schematic Diagram of the Basic System

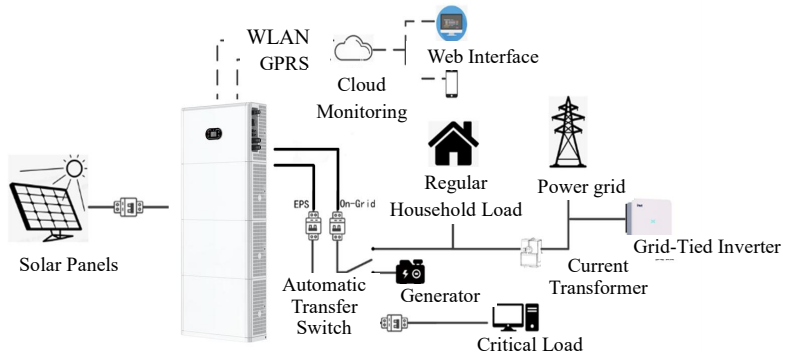

As illustrated above, a complete hybrid inverter system in the XD series is mainly composed of solar PV panels, the all-in-one hybrid inverter, and the power grid.

Note: The battery is an integral part of the hybrid inverter system. Please keep the installation environment well-ventilated and take necessary measures to control the ambient temperature, so as to prevent the risk of explosion caused by high temperature.

Battery characteristics:

Ingress protection:  $\geq$ IP65; pollution degree: PD2; indoor temperature: 0°C~40°C; RH: 5%~85%

### 3.5 Product Features

1. Intelligent management system and multiple working modes, meeting different customer needs.
2. Allowing you to set the priority of grid connection, battery type and other inverter information on the LCD screen.
3. Dual MPPT, high current input, compatible with large solar cell module of 210mm, flexible configuration;
4. All-in-one design, providing backup power and peak-shaving function.
5. With a battery safety management system, supporting remote upgrade of BMS system.
6. Supporting anti-reflux prevention.
7. Supporting over-temperature / over-current / short-circuit protection, ensuring safe, stable and reliable operation of the system.
8. Providing a variety of user-friendly communication modules (RS485, GPRS, Wi-Fi), supporting monitoring and remote operations through computer, mobile phone or Internet.
9. Supporting parallel configuration of a maximum of six inverters.
10. A maximum conversion efficiency of up to 97.5%.
11. IP65 rating, low weight, small size, easy installation.

## Chapter 4 Installation

### 4.1 Unpacking Inspection

The inverter has been fully tested and strictly inspected before delivery, but damage may still occur during transportation. Before unpacking, carefully check whether the product information indicated on the carton is consistent with that indicated in the Purchase Order, and whether the product package is in good condition. If any damage is detected, contact the carrier or your dealer and provide photos of the damaged area, so as to receive the fastest and best service.

To keep the inverter idle for a long time, please place it in the original carton and protect it against moisture and dust.

After taking the inverter out of the carton, please check the following:

- (1) Whether the inverter remains in good condition;
- (2) Whether you have received the User Manual and all of the connection parts and mounting parts;
- (3) Whether the items you have received are free from damage and shortage;
- (4) Whether the product information indicated in the nameplate on the inverter is consistent with that indicated in the Purchase Order;
- (5) Check with the List of Standard Deliverables below.

Standard deliverables for the hybrid inverter:

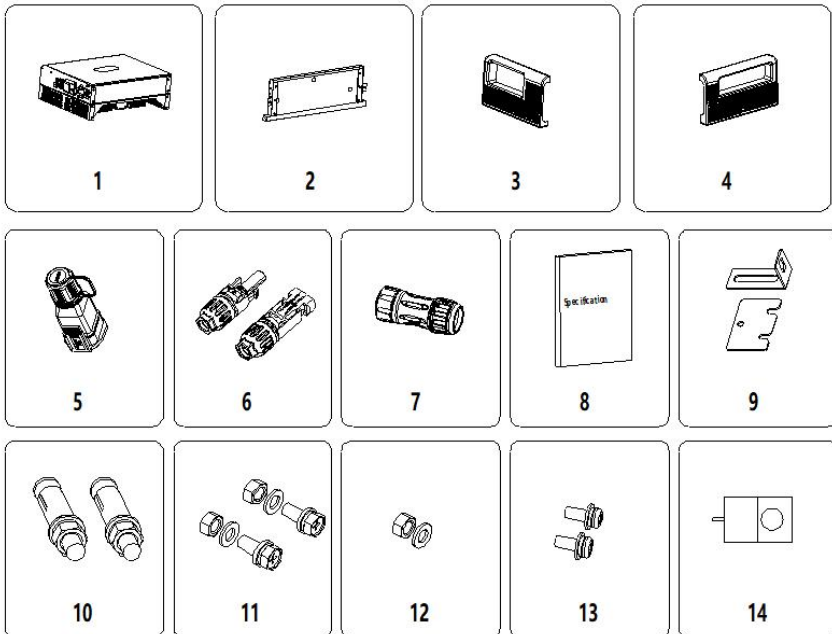

Fig. 4.1 Deliverables for Hybrid Inverter XD3K-6KTL-AIO

Table 4-1 List of Deliverables for Hybrid Inverter

No.	Name	Quantity
1	Inverter	1
2	Base	1
3	Left Side Panel	1
4	Right Side Panel	1
5	16-pin Terminal	1
6	DC Connector (pair)	2
7	GRID & EPS O-terminals	1
8	Accompanying Documents (set)	1
9	L-shaped & Square Connectors	2
10	Stainless Expansion Bolts M6*50	4
11	M6 Combination Bolts	6
12	M6 Flat Washers & Nuts	4
13	M4 screws	10
14	CT	1

Please check the above items carefully, and contact your dealer immediately if you have any questions.

## 4.2 Before installation

### 4.2.1 Installation Tools

Table 4-2 List of Installation Tools

No.	Installation Tools	Description
1	Marker	Mark mounting holes
2	Electric Drill	Drill holes in the mounting bracket or wall
3	Hammer	Drive expansion bolts
4	Adjustable Wrench	Fix the mounting bracket
5	Screwdriver	Fix the inverter and tighten the junction box
6	Slotted Screwdriver or Phillips Screwdriver	For AC wiring use
7	Megger	Measure the insulation performance and resistance to ground
8	Multimeter	Test circuits and measure AC/DC voltage
9	Electric Soldering Iron	Weld the communication cable
10	Wire Crimper	Crimp the DC terminal
11	Hydraulic Crimper	Crimp the AC O-terminal

### 4.2.2 Installation Conditions

- (1) The inverter can be installed in an indoor or outdoor environment.
- (2) During the operation of the inverter, the housing and heat sinks will heat up. Do not install the inverter where it can be accessed easily.
- (3) Do not install the inverter in an area where flammable or explosive materials are stored.
- (4) Install the inverter in a well-ventilated environment, so as to facilitate heat dissipation.
- (5) It is recommended to choose an installation position with shade, or build a sunshade.

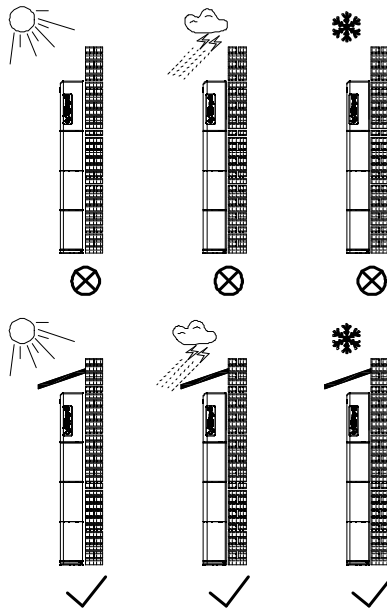

Fig. 4.2 Installation Conditions

- (6) The ambient temperature should be between  $-30^{\circ}\text{C}$ ~ $60^{\circ}\text{C}$ .
- (7) Install the inverter away from electronic devices with strong electromagnetic interference.
- (8) The product should be installed on a fixed and solid object surface, such as a wall or metal bracket.
- (9) The installation position must provide reliable grounding for the inverter, and the grounding metal conductor must be made of the same material as the reserved grounding metal conductor of the inverter.

### 4.3 Space Requirements

- (1) Leave adequate space around the inverter to facilitate assembly and disassembly of the inverter. See Fig. 4.3.

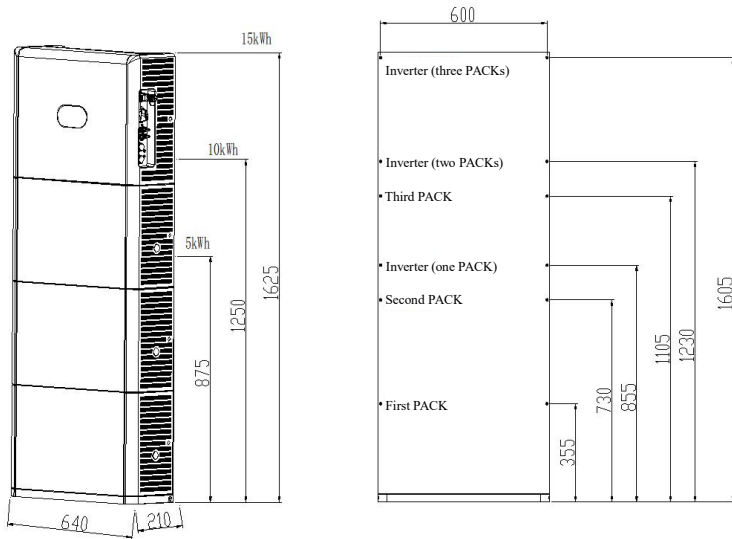

Fig. 4.3 Installation Spacing of Inverter

(2) To install more than one inverter, please keep a certain distance between the inverters and on both sides of the inverters (see Fig. 4.4), so as to facilitate heat dissipation.

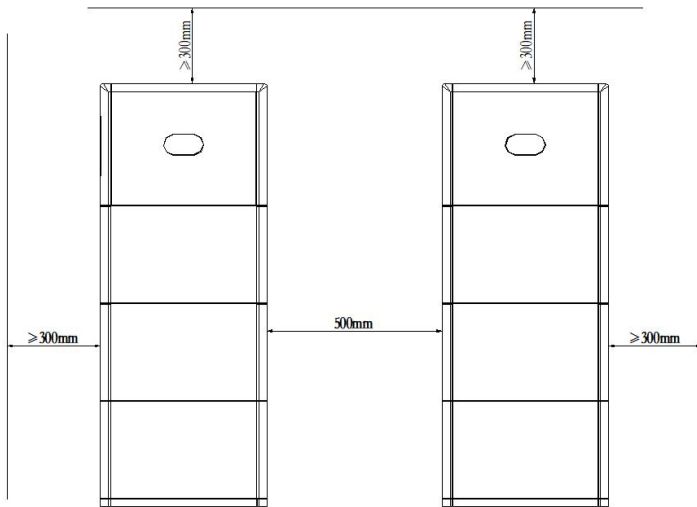

Fig. 4.4 Installation Dimension of Side-by-side Inverters

## 4.4 Inverter Dimension and Weight

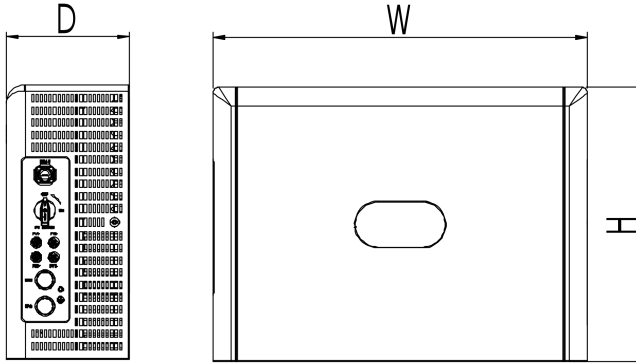

Fig. 4.5 Overall Dimension of Inverter

Dimension and net weight of Hybrid Inverter:

Model No.	Height (H) (mm)	Width (W) (mm)	Depth (D) (mm)	Net Weight (kg)
XD3K-6KTL-AIO	470	640	210	30.2

Packaging Dimensions and Gross Weight

Model No.	Height (H) (mm)	Width (W) (mm)	Depth (D) (mm)	Weight (kg)	Material
XD3K-6KTL-AIO	545	675	335	35	Corrugated cardboard box

## 4.5 Drilling

Position the battery base against the wall with a 10-20mm gap. Indicate the position of the fixation holes on the base with a marker. Mark the hole position for the L-shaped side brackets based on the diagram. Drill all holes at  $\phi 8 \times 55$  size.

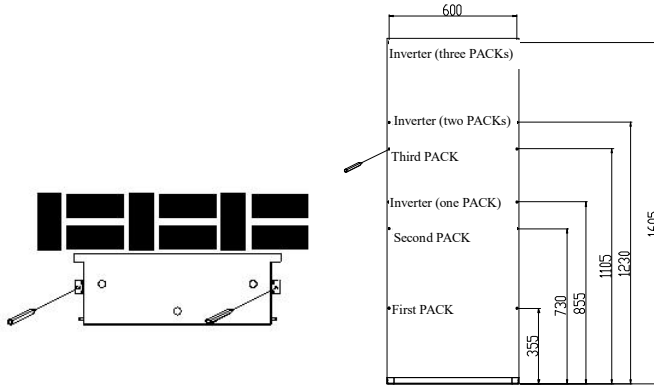

Fig. 4.6 Drilling Holes

## 4.6 Battery Base Installation

Place the battery base and drive the M6\*50 expansion bolts into the holes using a rubber hammer. Tighten the nut to secure the bolt's end using a wrench, then remove the nut, spring washer, and flat washer. Secure the battery base to the ground using a torque of 5N•m.

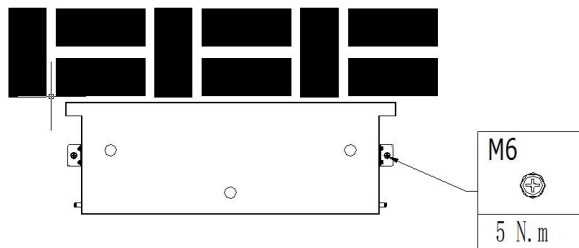

Fig. 4.7 Base Installation

## 4.7 Battery Placement

Align the three protruding tabs on the bottom of the battery with the three round holes in the base. Place the square connector at the junction of the battery and base on the side, and then use the M4x10 screws to fix the square connector in place. Tighten with a torque of 1.2N•m.

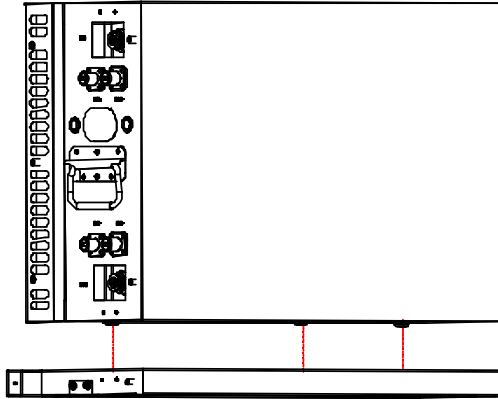

Fig. 4.8 Battery Placement

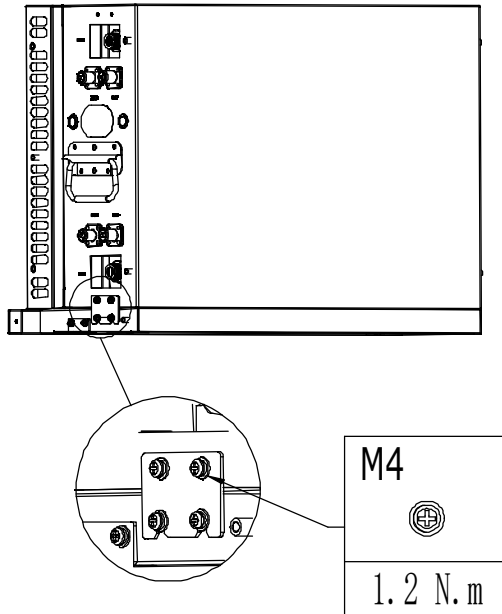

Fig. 4.9 Battery & Base Side Fixation



## 4.8 Installation of Inverter

Position the inverter on top of the battery. Align the three protruding tabs on the inverter's bottom with the three recesses on the battery's top. Place the square connector at the junction of the battery and inverter on the side, and then use the M4x10 screws to fix the square connector in place. Tighten with a torque of  $1.2\text{N}\cdot\text{m}$ . Next, take the L-shaped connectors and the M6 combination bolts. Fix the longer side of the L-shaped connectors to the side of the inverter and battery in advance. Align the shorter side of the L-shaped connector with the holes in the wall. Drive the M6\*50 expansion bolts into the holes using a rubber hammer. Tighten the nut to fix the bolt's end using a wrench, then remove the nut, spring washer, and flat washer. Secure the L-shaped connector to the wall with a tightening torque of  $5\text{N}\cdot\text{m}$ . Finally, tighten the L-shaped connector to the sides of the inverter and battery with a tightening torque of  $1.2\text{N}\cdot\text{m}$ .

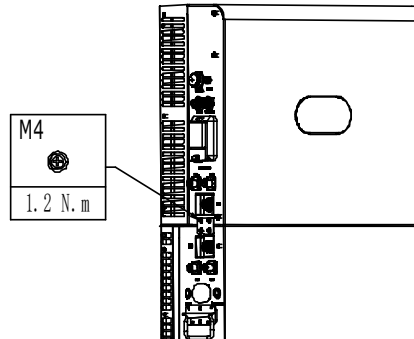

Fig. 4.10 Installation of Inverter

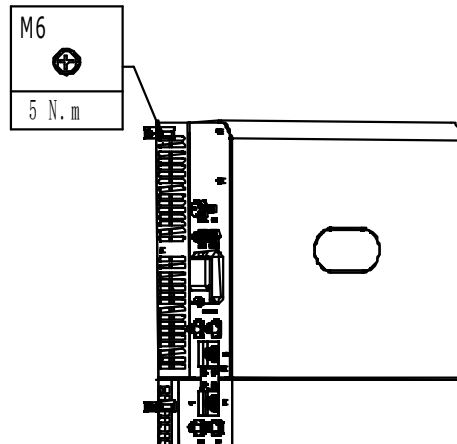

Fig. 4.11 Installation of L-shaped Side Brackets

## Chapter 5 Electrical Connection

### 5.1 Electrical Connection Overview

This product supports the following power grid systems.

Note: If the power grid system contains an N wire, the neutral to ground voltage should be lower than 10V.

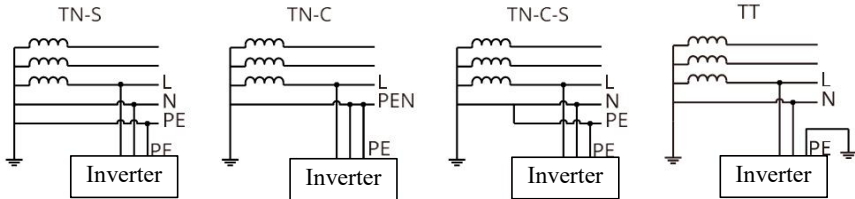

#### NOTE

- The connection modes between the N wire and PE wire at the GRID port and EPS port of the inverter may vary in different regions. Please consult your local regulatory requirements.
- The GRID port and EPS AC port of the inverter have built-in relays. When the inverter works in off-grid state, the built-in GRID relay will be open; when the inverter works in on-grid state, the built-in GRID relay will be closed.
- When the inverter is powered on, the EPS AC port will be charged; if you need to perform maintenance of the EPS load, please power off the inverter first in order to avoid electric shock.

#### NOTE

The following wiring method is applicable to Australia, New Zealand and South Africa.

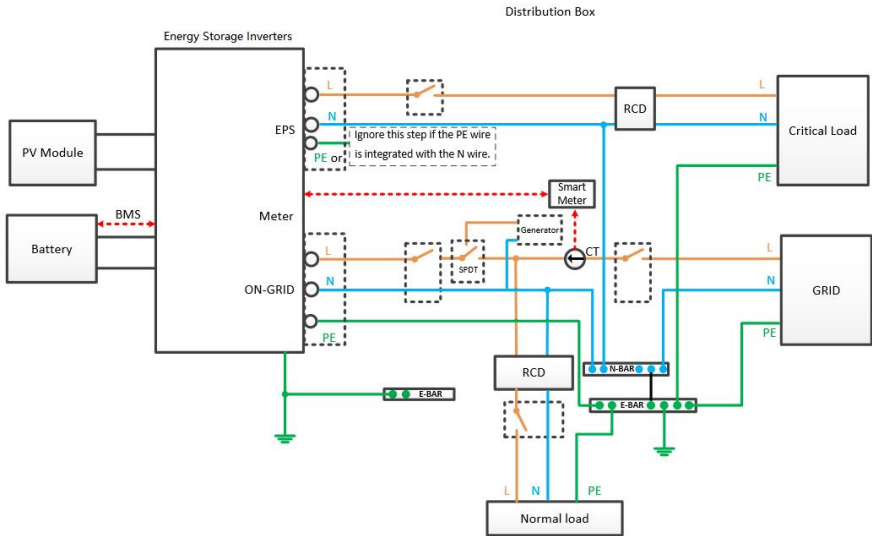

**NOTE**

- Make sure the BACK-UP grounding wire is properly connected and secured; otherwise, the BACK-UP function may fail in the case of power grid failure.
- The following wiring method is applicable for regions other than Australia, New Zealand and South Africa.

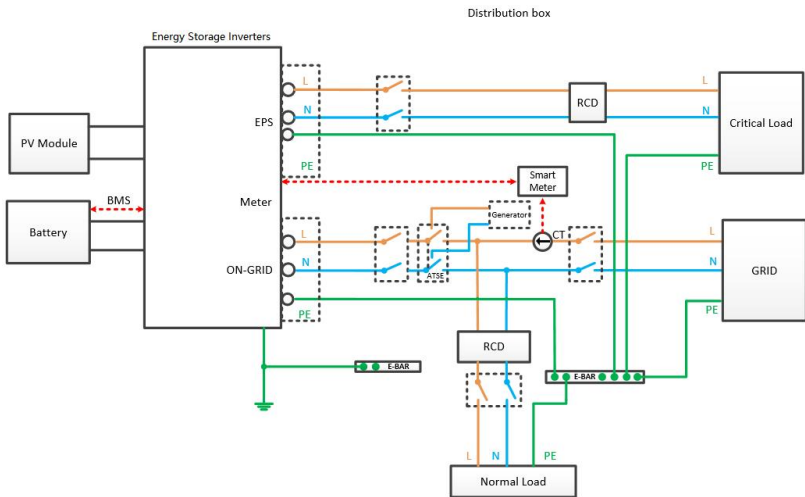

## 5.2 Battery-to-Battery and Battery-to-Inverter Power & Communication Wiring

1. Battery-to-Battery: Use BAT+ (or BAT-) power cables to connect two batteries' BAT+ (or BAT-) ports. Use communication cables to connect the Link Port Out port to the Link Port In port.
2. Battery-to-Inverter: Use BAT+ (or BAT-) power cables to connect the battery and inverter's BAT+ (or BAT-) ports. Use a network cable to connect the battery's Link Port Out to the inverter's BMS.

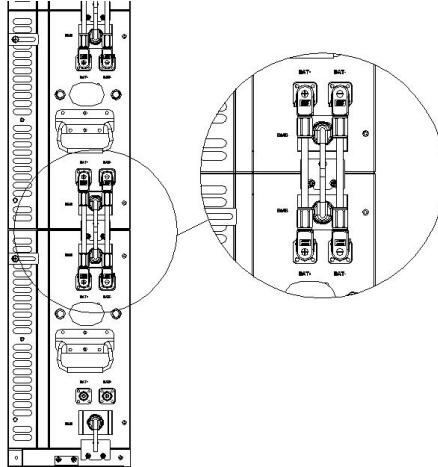

Fig. 5.1 Battery-to-Battery and Battery-to-Inverter Connection

## 5.3 Side Panel Installation

- Take the side panels for the inverter, battery, and base. Attach the panels to the sides of the inverter and battery. Use M4x10 screws to secure the side panels with a torque of 1.2N•m.

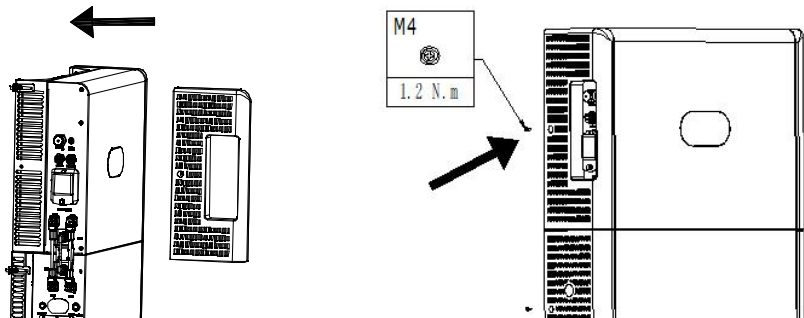
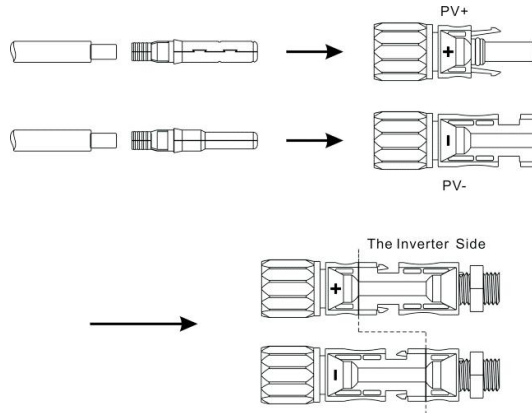

Fig. 5.2 Side Panel Installation

## 5.4 PV Wiring

MC4 connectors are provided at DC input side of the hybrid inverter. Below are the connection steps:

1. Turn off the DC switch.
2. Connect the positive terminal and negative terminal of the PV module respectively to the PV+ port and PV- port of the hybrid inverter. Make sure the actual input voltage and current fall within the allowable range.



- Maximum allowable PV input voltage: 600V (Please consider changes in the voltage at the minimum temperature).

- Maximum allowable PV input current: 16A

Note: It is recommended to use a specialized PV cable  $\geq 4\text{mm}^2$  (11AWG).

## 5.5 AC Wiring

The AC output is located at the bottom right of the hybrid inverter. The upper terminal is for grid connection, and the lower terminal is for off-grid connection (refer to the chapter Product Introduction for detailed information).

Step 1: Unscrew the AC terminal, and then use an appropriate tool to remove it as shown below.

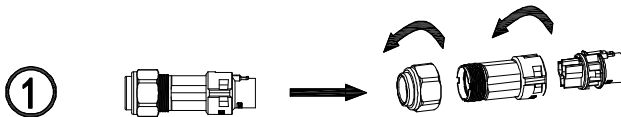

Step 2: Pass the cable through the rubber nut, sealing ring and threaded sleeve in turn. Connect the cable to the corresponding terminal with the correct polarity mark, and then tighten the threaded sleeve onto the AC terminal as shown below:

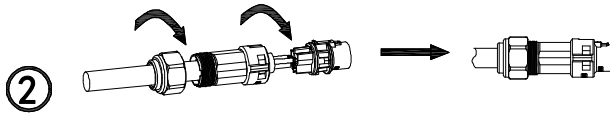

Step 3: Connect the prepared AC terminal to the EPS port or GRID port of the hybrid inverter as shown below.

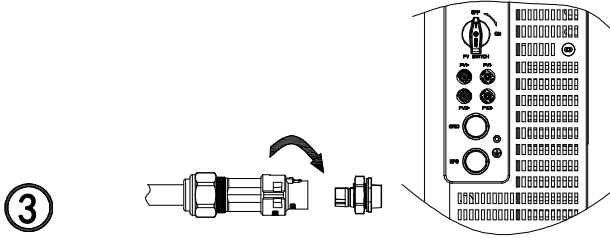

- Note:
1. If you use the grid connection function only, connect the power grid to the GRID port of the inverter.
  2. Do not connect the GRID port directly to the EPS port, as this could cause damage to the inverter.
  3. Do not connect the power grid to the EPS port, as this could cause damage to the inverter.
  4. Power cable for GRID port or EPS port shall be  $\geq 4\text{mm}^2$  (11AWG).

## 5.6 CT Connection

The current transformer (CT) used on the inverter can help monitor the energy use of the home user. Below are the CT connection steps.

1. Secure the positive and negative wires of the CT to the orange terminals. The black and white wire is positive, while the black wire is negative.
2. Thread both wires through the 16-pin terminal casing and connect them to the wiring terminal: the positive wire to pin 13 and the negative wire to pin 12.
3. Fit the wiring terminal to the 16-pin terminal casing closely and finally connect it to the inverter's COM-2 terminal.
4. Connect the other end of the CT to the GRID's L wire, ensuring the arrow points towards the inverter.

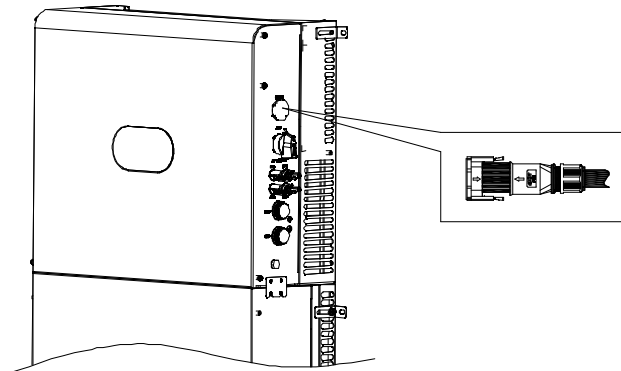

Fig. 5.3 COM-2 Terminal Connection

Make sure the current transformer is installed properly in the correct direction as shown in Fig. 5.4.

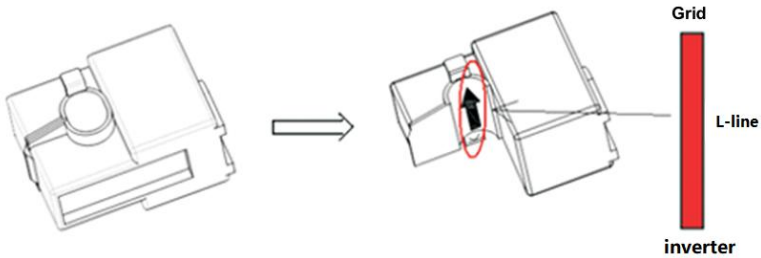

Fig. 5.4 Current Transformer Direction

Turn on the current transformer, and you will see an arrow indicating the direction of the current, as shown in Fig. 5.4. Thread the L wire through the detection hole of the current transformer and then lock the current transformer.

Note: The direction of the arrow (from K to L) corresponds to the direction from grid to load in the L line. The communication distance should be less than 30m.

### 5.7 Connection of Smart Meter

End users can also monitor home consumption with a smart meter. You can connect the communication cable of the smart meter as described below.

Connect ports 24 and 25 of the meter to pins 15 and 16 of the COM-2 respectively. Refer to the CT wiring method in the image below:

Note: you cannot install the smart meter and CT at the same time, but select either CT or Meter as the sensor mode as described in Chapter 7.

Below is the connection diagram of CHINT smart meter:

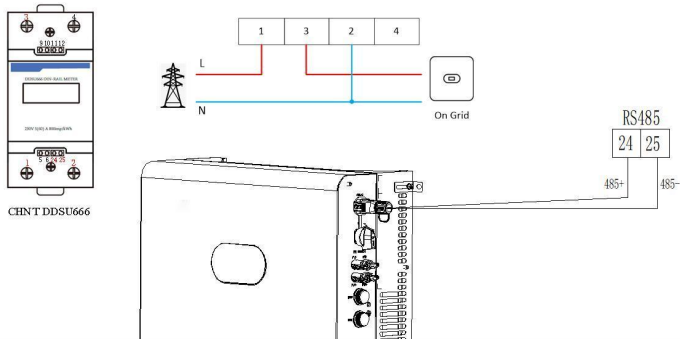

Fig. 5.5 Meter Wiring

### 5.8 Connection of Grounding Wire

The hybrid inverter should be grounded reliably. The grounding wire size should be  $\geq 10\text{mm}^2$ . The grounding point (GND) is shown in Fig. 5.6.

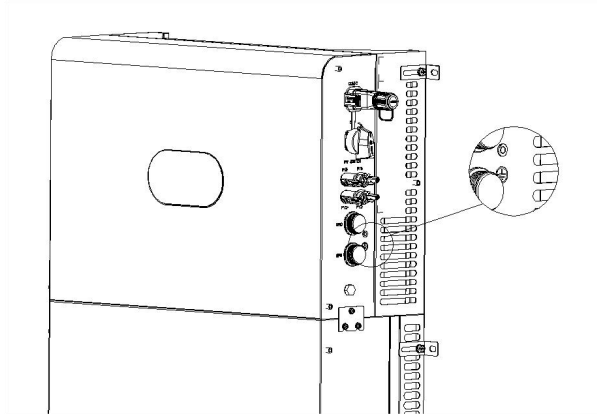
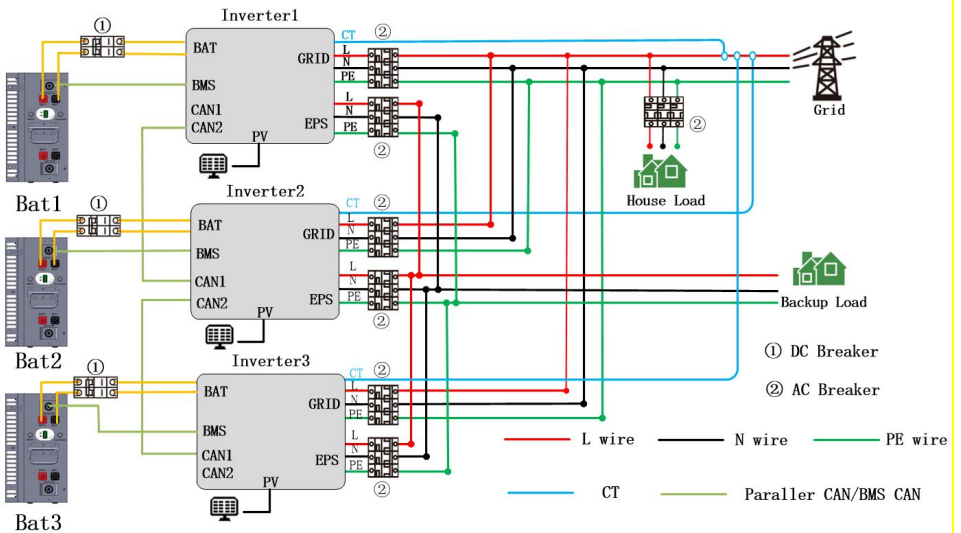

Fig. 5.6 Inverter Grounding

### 5.9 Parallel Connection Wiring





Master-Slave Setting:

<div style="border: 1px solid black; padding: 5px;"> <p style="text-align: center;">Setting Info</p> <p>10. Anti-Reflux Setting</p> <p style="background-color: black; color: white;">11. Set Parallel Role</p> </div>	<p>→</p> <p>Press the OK key.</p>	<div style="border: 1px solid black; padding: 5px;"> <p style="text-align: center;">Set Parallel Role</p> <p style="background-color: black; color: white;">Role: 1 Phase Master</p> <p style="text-align: center;">OK</p> </div>
<div style="border: 1px solid black; padding: 5px;"> <p style="text-align: center;">Set Parallel Role</p> <p style="background-color: black; color: white;">Role: 1 Phase Master</p> <p style="text-align: center;">OK</p> </div>	<p>→</p> <p>Press the Up or Down key to select master and slave mode.</p>	<div style="border: 1px solid black; padding: 5px;"> <p style="text-align: center;">Set Parallel Role</p> <p style="background-color: black; color: white;">Role: 2 Slave</p> <p style="text-align: center;">OK</p> </div>
<p>▼ Press the OK key.</p>		<p>▼ Press the OK key.</p>
<div style="border: 1px solid black; padding: 5px;"> <p style="text-align: center;">Set Parallel Role</p> <p>Role: 2 Slave</p> <p style="background-color: black; color: white; text-align: center; margin-top: 20px;">OK</p> </div>	<p>→</p> <p>Press the OK key.</p>	<div style="border: 1px solid black; padding: 5px;"> <p style="text-align: center;">Set Parallel Role</p> <p>Role: 2 Slave</p> <p style="background-color: black; color: white; text-align: center; margin-top: 20px;">Setting</p> </div>
		<p>▼ Wait for 3 seconds.</p>
		<div style="border: 1px solid black; padding: 5px;"> <p style="text-align: center;">Set Parallel Role</p> <p>Role: 2 Slave</p> <p style="background-color: black; color: white; text-align: center; margin-top: 20px;">Setting Ok!/Fail!</p> </div>

## Chapter 6 Commissioning

### 6.1 Startup

Step 1: Close the AC circuit breaker of the inverter at GRID side.

Step 2: Close the DC circuit breaker of the inverter at BAT side.

Step 3: Close the AC circuit breaker of the inverter at EPS side.

Step 4: Turn on the PV switch of the inverter.

Note: The system will work in On Grid state upon normal connections at PV side, GRID side and BAT side.

The green LED will remain on, and the message "State: On Grid" will appear on the screen of the hybrid inverter.

### 6.2 Shutdown

To stop the operation of the hybrid inverter, please disconnect all energy sources to enter automatic shutdown.

Step 1: Turn off the PV switch.

Step 2: Turn off the BAT switch.

Step 3: Disconnect the power grid.

Both the LED light and LCD screen will be turned off.

Note: At the end of the above steps, please wait at least 5 minutes before proceeding to other operations.

## Chapter 7 Parameter Settings

On the LCD screen, you can check the current state of the system, energy flow diagram, operation information and fault information, or set the language, charge and discharge priority and system time. The main screen shows the energy flow diagram by default.

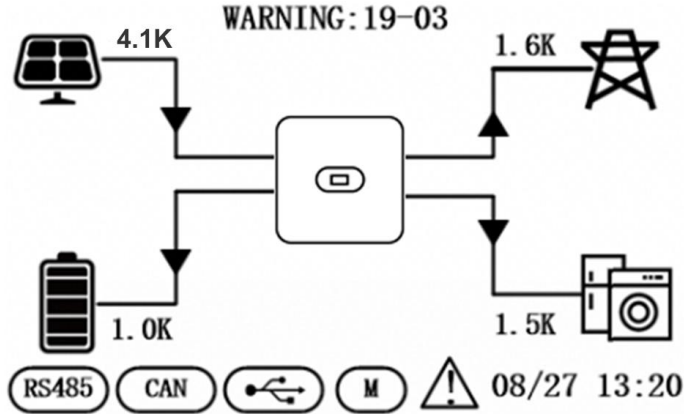

Below are the possible states of the inverter:

1. Initializing: In standby mode when no fault is detected, the inverter gets into waiting state for some reason.
2. Waiting: The inverter enters self-check. If no fault is detected, the system will enter standby mode or normal working mode.
3. On Grid: The inverter is working in on-grid state.
4. Fault: In case of a fault, the inverter will stop working and get into protected mode.
5. Programming: The inverter is currently programming.
6. Off Grid: The inverter is working in off-grid state.

### 7.1 Menu Information

On the main screen, press the OK, ESC, Up or Down key to go to the Menu Info page. The Menu Info page is shown below.

Menu Info
1. PV Info
2. AC Output Info
3. BAT Info
4. EPS Output Info
5. Basic Info
6. Energy Info
7. Fault Info
8. Setting Info

On the Menu Info page, press the Up or Down key to select a menu item. The page of each menu item is shown below.

### 7.1.1 PV Input Information

Here you can check the PV input voltage, current and power.

Menu Info
1. PV Info
2. AC Output Info
3. BAT Info
4. EPS Output Info
5. Basic Info
6. Energy Info
7. Fault Info
8. Setting Info



Press the Enter key to go to the PV Info page.



PV Info	
PV Volt:	235.6V / 256.8V
PV Curr:	13.6A / 16.8A
PV Power:	3448.9W / 4314.2W

Press the ESC key to exit the PV Info page.

### 7.1.2 AC Output Information

Here you can check the AC voltage, frequency and current as well as the meter power.

Menu Info
1. PV Info
2. AC Output Info
3. BAT Info
4. EPS Output Info
5. Basic Info
6. Energy Info
7. Fault Info
8. Setting Info



Press the Enter key to go to the AC Output Info page.



AC Output Info	
AC Volt:	235.6V
AC Freq:	50.1Hz
AC Curr:	30.6A
METER Power:	-2443.3W

Press the ESC key to exit the AC Output Info page.

### 7.1.3 Battery Information

Here you can check the battery type, voltage, current and power as well as the battery SOC.

Menu Info
1. PV Info
2. AC Output Info
3. BAT Info
4. EPS Output Info
5. Basic Info
6. Energy Info
7. Fault Info
8. Setting Info



Press the Enter key to go to the Battery Info page.



BAT Info	
BAT Type:	lead acid
BAT Volt:	47.3V
BAT Curr:	97.5A
BAT Power:	4526.6W
BAT SOC:	87%

Press the ESC key  
to exit the Battery  
Info page.

### 7.1.4 EPS Output Information

Here you can check the EPS voltage, frequency, current and power as well as the load power.

Menu Info
1. PV Info
2. AC Output Info
3. BAT Info
4. EPS Output Info
5. Basic Info
6. Energy Info
7. Fault Info
8. Setting Info



Press the Enter  
key to go to the  
EPS Output Info  
page.

EPS Output Info	
EPS Volt:	230. 5V
EPS Freq:	50. 0Hz
EPS Curr:	10. 6A
EPS Power:	2443. 3W



Press the ESC  
key to exit the  
EPS Output Info  
page.

### 7.1.5 Basic Information

Here you can check the date & time, rated power, serial number, communication address and firmware version.

Menu Info
1. PV Info
2. AC Output Info
3. BAT Info
4. EPS Output Info
5. Basic Info
6. Energy Info
7. Fault Info
8. Setting Info



Press the Enter  
key to go to the  
Basic Info page.

Basic Info	
Date & Time :	22/08/23 11:40
Rate Power :	6000W
Model:	00F0-0980-0030-0900
SN:	F00123456790
COM Addr:	1
FW:	510-012-109-1102



Press the ESC  
key to exit the  
Basic Info page.

### 7.1.6 Energy Information

Here you can check daily and total energy generated by inverter, as well as daily battery charging/discharging

energy and total battery charging/discharging energy.

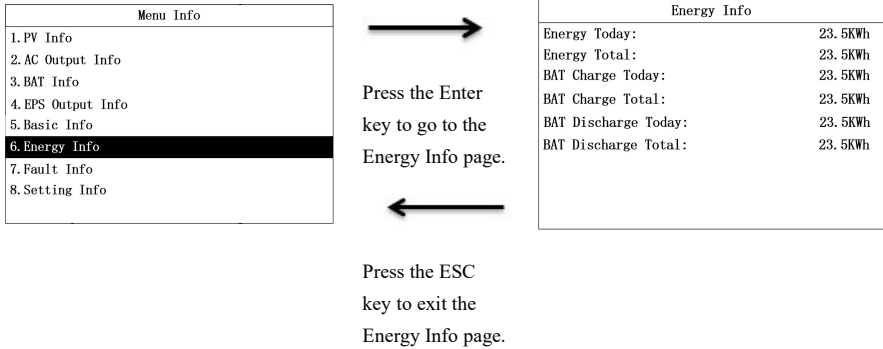

### 7.1.7 Fault Information

Here you can check the total number of fault logs as well as the fault code, date and time of each fault.

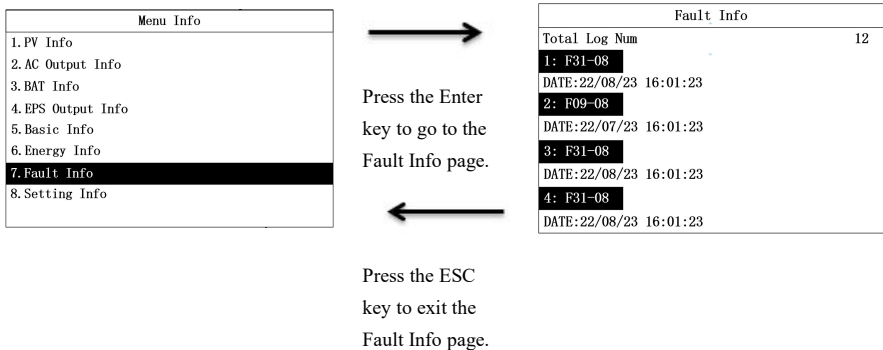

### 7.1.8 Setting Information

To access the Setting Info page, you need to enter the password. On the Menu Info page, select "Setting Info" to go to the Input Password page.

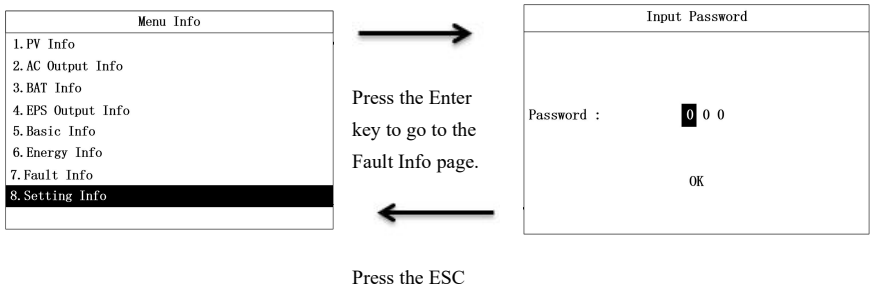

key to exit the Fault Info page.

Enter the password in the following steps.

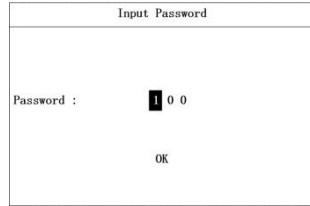
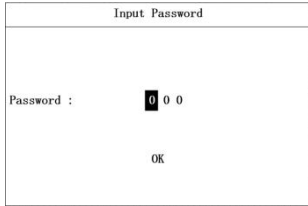

Press the Up or Down key to increase or reduce the number.

▼ Press the OK key.

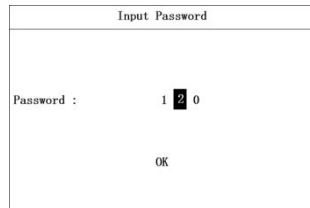
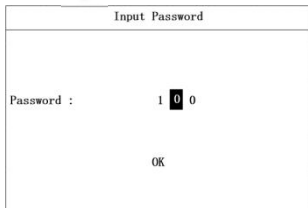

Press the Up or Down key to increase or reduce the number.

▼ Press the OK key.

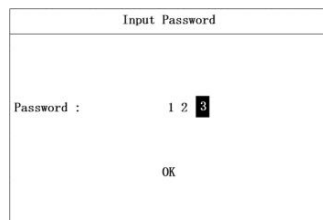
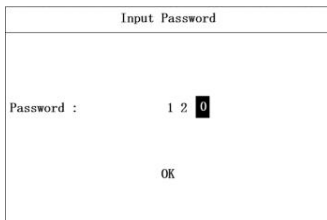

Press the Up or Down key to increase or reduce the number.

▼ Press the OK key.

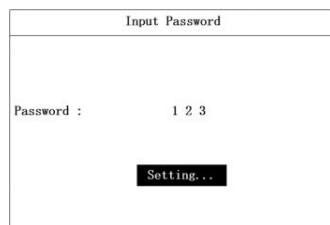
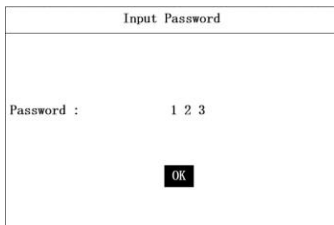

Press the Up or Down key to increase or reduce the number.

▼ Wait for 3 seconds.

Input Password	
Password :	1 2 3
<b>Setting Ok!</b>	

## 7.2 "Setting Info" Page

On the Setting Info page, you can set such parameters as the date & time, COM address, language, country, and priority. The Setting Info page is shown below.

Setting Info
<b>1. Date &amp; Time Setting</b>
2. COM Address Setting
3. Language Setting
4:BAT & Meter Setting
5. Country Setting
6. Off Grid Setting
7. Priority Setting
8. AutoTest Setting
9. Restore Factory Setting

### 7.2.1 Date & Time Setting

Setting Info
<b>1. Date &amp; Time Setting</b>
2. COM Address Setting
3. Language Setting
4:BAT & Meter Setting
5. Country Setting
6. Off Grid Setting
7. Priority Setting
8. AutoTest Setting
9. Restore Factory Setting



Press the OK key.

Date & Time Setting
Day-Month-Year: 24 / 02 / 23
Hour-Min-Sec: 19: 41 : 39
OK



Date & Time Setting

Day-Month-Year: 24 / 02 / 23  
Hour-Min-Sec: 19:41:39

OK



Press the Up or Down key to increase or reduce the number.

Date & Time Setting

Day-Month-Year: 25 / 08 / 22  
Hour-Min-Sec: 19:41:39

OK



Press the OK key.

Date & Time Setting

Day-Month-Year: 25 / 08 / 22  
Hour-Min-Sec: 19:41:39

OK



Press the Up or Down key to increase or reduce the number.

Date & Time Setting

Day-Month-Year: 25 / 09 / 22  
Hour-Min-Sec: 19:41:39

OK



Press the OK key.

Date & Time Setting

Day-Month-Year: 25 / 08 / 22  
Hour-Min-Sec: 19:41:39

OK



Press the Up or Down key to increase or reduce the number.

Date & Time Setting

Day-Month-Year: 25 / 08 / 23  
Hour-Min-Sec: 19:41:39

OK



Press the OK key.

Date & Time Setting

Day-Month-Year: 25 / 08 / 22  
Hour-Min-Sec: 19:41:39

OK



Press the Up or Down key to increase or reduce the number.

Date & Time Setting

Day-Month-Year: 25 / 08 / 22  
Hour-Min-Sec: 20:41:39

OK



Press the OK key.

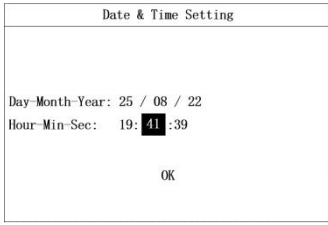

Press the Up or Down key to increase or reduce the number.

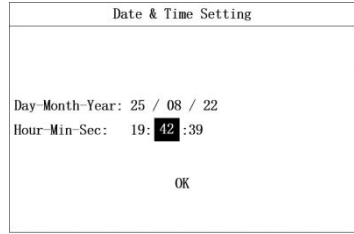

Press the OK key.

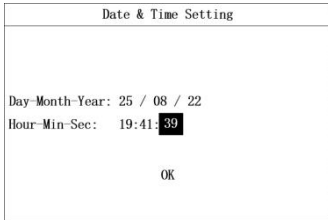

Press the Up or Down key to increase or reduce the number.

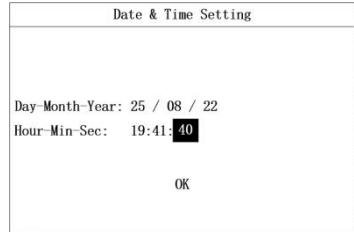

Press the OK key.

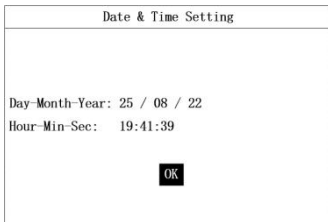

Press the OK key.

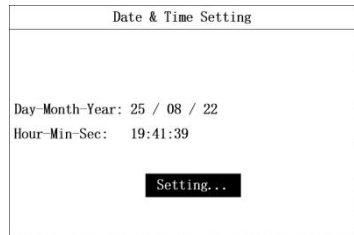

Wait for 3 seconds.

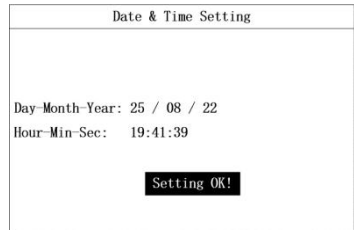

### 7.2.2 COM Address Setting

Setting Info
1.Date & Time Setting
<b>2.COM Address Setting</b>
3. Language Setting
4:BAT & Meter Setting
5. Country Setting
6. Off Grid Setting
7. Priority Setting
8. AutoTest Setting
9. Restore Factory Setting



Press the OK key.

COM Address Setting
Address: 0 0 1
OK

COM Address Setting
Address: 0 0 1
OK



Press the Up or Down key to increase or reduce the number.

COM Address Setting
Address: 0 1 1
OK



Press the OK key.

COM Address Setting
Address: 0 0 1
OK



Press the Up or Down key to increase or reduce the number.

COM Address Setting
Address: 0 1 1
OK



Press the OK key.

COM Address Setting
Address: 0 0 1
OK



Press the Up or Down key to increase or reduce the number.

COM Address Setting
Address: 0 0 2
OK



Press the OK key.

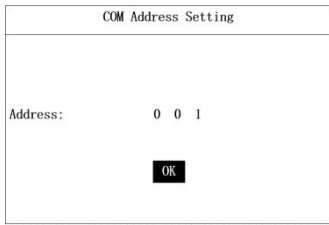

→

Press the OK key.

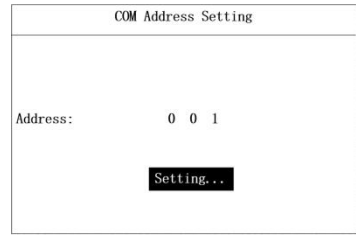

⏏ Wait for 3 seconds.

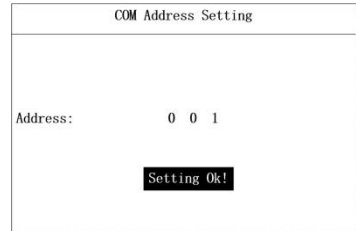

### 7.2.3 Language Setting

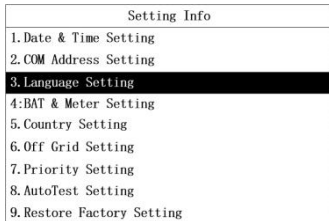

→

Press the OK key.

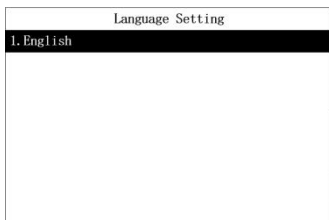
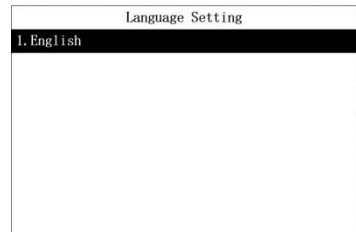

→

Press the OK key.

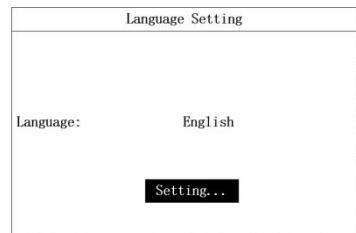

⏏ Wait for 3 seconds.

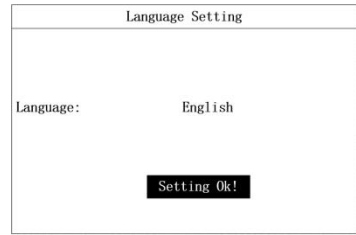

### 7.2.4 Meter Settings

On the BAT & Meter Setting page, you can select the CT mode or a meter manufacturer. See the following steps.

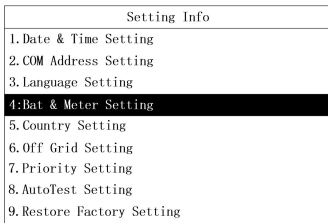

Press the OK key.

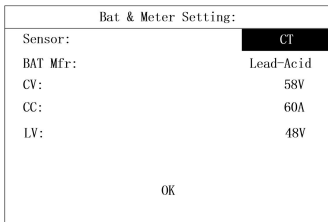
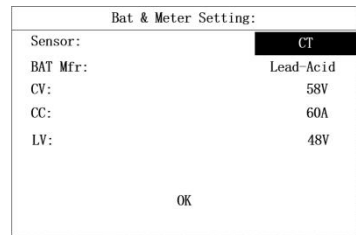

Press the Up or Down key to select the CT mode or a meter manufacturer.

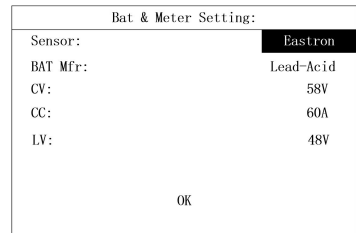

Press the OK key.

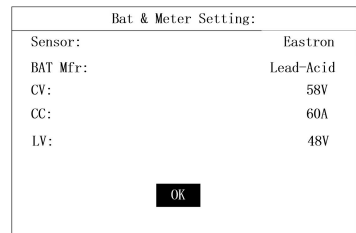

Press the OK key.

Bat & Meter Setting:	
Sensor:	Eastron
BAT Mfr:	Lead-Acid
CV:	58V
CC:	60A
LV:	48V
Setting...	



Press the OK key.

Bat & Meter Setting:	
Sensor:	Eastron
BAT Mfr:	Lead-Acid
CV:	58V
CC:	60A
LV:	48V
Setting Ok!	

### 7.2.5 BAT Setting

The parameters displayed on the BAT & Meter Setting page depend on the battery manufacturer. If you select a lithium battery manufacturer, the configurable battery parameters will include Maximum Charge Current and Maximum Discharge Current. You can set the lithium battery parameters in the following steps.

Setting Info
1.Date & Time Setting
2.COM Address Setting
3.Language Setting
<b>4:Bat &amp; Meter Setting</b>
5.Country Setting
6.Off Grid Setting
7.Priority Setting
8.AutoTest Setting
9.Restore Factory Setting



Press the OK key.

Bat & Meter Setting:	
Sensor:	CT
BAT Mfr:	Lead-Acid
CV:	58V
CC:	60A
LV:	48V
OK	



Press the OK key.

Bat & Meter Setting	
Sensor:	CT
BAT Mfr:	ATL
Charge Curr:	60A
Discharge Curr:	60A
OK	



Press the Up or Down key to select a lithium battery manufacturer.

Bat & Meter Setting	
Sensor:	CT
BAT Mfr:	VestWoods
Charge Curr:	60A
Discharge Curr:	60A
OK	



Press the OK key.

Bat & Meter Setting	
Sensor:	CT
BAT Mfr:	ATL
Charge Curr:	60A
Discharge Curr:	60A
OK	



Press the Up or Down key to increase or reduce the maximum charge current value.

Bat & Meter Setting	
Sensor:	CT
BAT Mfr:	ATL
Charge Curr:	61A
Discharge Curr:	60A
OK	

Bat & Meter Setting	
Sensor:	CT
BAT Mfr:	ATL
Charge Curr:	60A
Discharge Curr:	60A
OK	



Press the Up or Down key to increase or reduce the maximum discharge current value.

Bat & Meter Setting	
Sensor:	CT
BAT Mfr:	ATL
Charge Curr:	60A
Discharge Curr:	61A
OK	



Press the OK key.

Bat & Meter Setting	
Sensor:	CT
BAT Mfr:	ATL
Charge Curr:	60A
Discharge Curr:	60A
OK	



Press the OK key.

Bat & Meter Setting	
Sensor:	CT
BAT Mfr:	ATL
Charge Curr:	60A
Discharge Curr:	60A
Setting...	



Wait for 3 seconds.

Bat & Meter Setting	
Sensor:	CT
BAT Mfr:	ATL
Charge Curr:	60A
Discharge Curr:	60A

**Setting Ok!**

### 7.2.6 Country Setting

Setting Info
1. Date & Time Setting
2. COM Address Setting
3. Language Setting
4. BAT & Meter Setting
<b>5. Country Setting</b>
6. Off Grid Setting
7. Priority Setting
8. AutoTest Setting
9. Restore Factory Setting



Press the OK key.

Country Setting	1/2
1. CQC2013	
<b>2. SKYWORTH</b>	
3. EN50549	
4. ITALY	
5. SPAIN	
6. NRS	
7. HUNARY	
8. BELGAIN	
9. AUSTRALIAN WEST	

Country Setting	1/2
1. CQC2013	
<b>2. SKYWORTH</b>	
3. EN50549	
4. ITALY	
5. SPAIN	
6. NRS	
7. HUNARY	
8. BELGAIN	
9. AUSTRALIAN WEST	



Press the Up or Down key to select the country associated with the applicable safety standards.

Country Setting	1/2
1. CQC2013	
2. SKYWORTH	
<b>3. EN50549</b>	
4. ITALY	
5. SPAIN	
6. NRS	
7. HUNARY	
8. BELGAIN	
9. AUSTRALIAN WEST	



Press the OK key.

Country Setting	
Country:	EN50549

**Setting...**



Wait for 3 seconds.



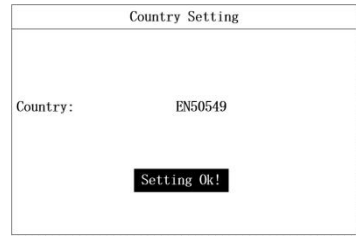

### 7.2.7 Off Grid Setting

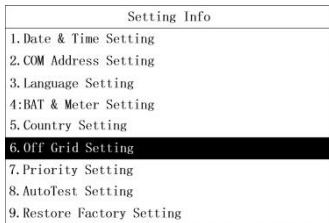

Press the OK key.

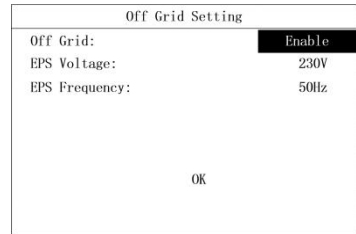

Disable the off-grid mode in the following steps.

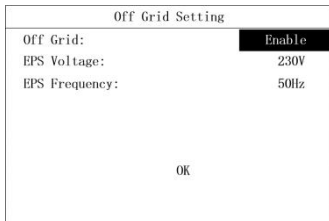

Press the Up or Down key to select "Enable" or "Disable".

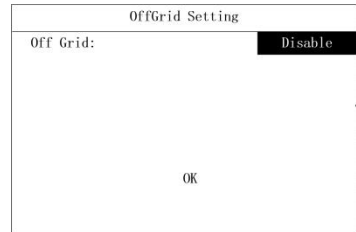

Press the OK key.

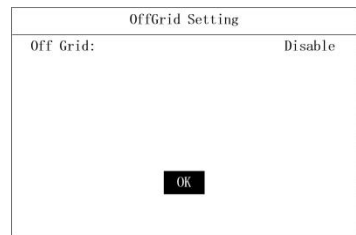

Press the OK key.

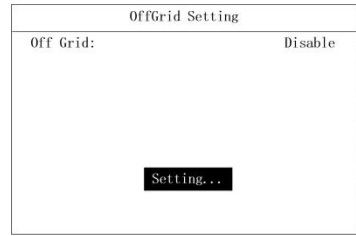

▼ Wait for 3 seconds.

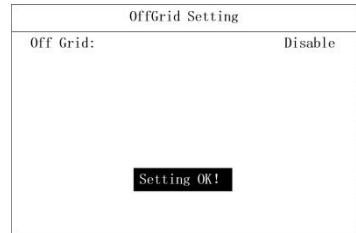

Enable the off-grid mode and set the EPS voltage and frequency in the following steps.

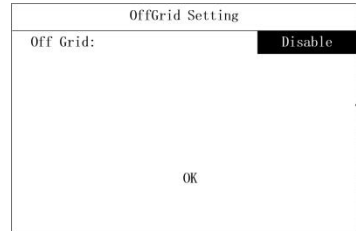
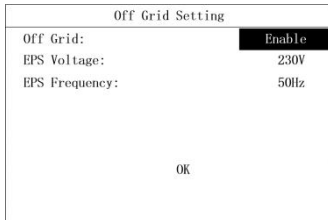

Press the Up or Down key to select "Enable" or "Disable".

▼ Press the OK key.

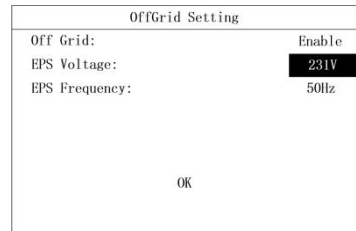
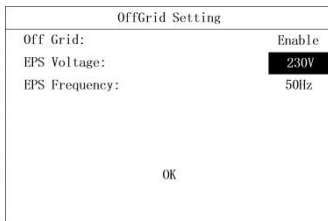

Press the Up or Down key to increase or reduce the EPS voltage value.

▼ Press the OK key.

OffGrid Setting	
Off Grid:	Enable
EPS Voltage:	231V
EPS Frequency:	50Hz
OK	



Press the Up or Down key to increase or reduce the EPS frequency value.

OffGrid Setting	
Off Grid:	Enable
EPS Voltage:	231V
EPS Frequency:	51Hz
OK	



Press the OK key.

OffGrid Setting	
Off Grid:	Enable
EPS Voltage:	231V
EPS Frequency:	50Hz
OK	

Press the OK key.

OffGrid Setting	
Off Grid:	Enable
EPS Voltage:	231V
EPS Frequency:	50Hz
Setting...	



Press the OK key.

OffGrid Setting	
Off Grid:	Enable
EPS Voltage:	231V
EPS Frequency:	50Hz
Setting OK!	

### 7.2.8 Priority Setting

Priority setting includes Bat First mode and Grid First mode.

Setting Info	
1. Date & Time Setting	
2. COM Address Setting	
3. Language Setting	
4. BAT & Meter Setting	
5. Country Setting	
6. Off Grid Setting	
7. Priority Setting	
8. AutoTest Setting	
9. Restore Factory Setting	



Press the OK key.

Priority Setting	
1. Bat First Setting	
2. Grid First Setting	

Set the Bat First mode in the following steps.

Priority Setting	
1. Bat First Setting	
2. Grid First Setting	



Press the OK key.

Bat First Setting	
AC Charge:	Enable
Time Interval:	1
Time Active:	Enable
Time:	01:00 - 05:00
Stop Charge SOC:	50%
Charge Power:	50%
OK	

Bat First Setting	
AC Charge:	Enable
Time Interval:	1
Time Active:	Enable
Time:	01:00 - 05:00
Stop Charge SOC:	50%
Charge Power:	50%
OK	



Press the Up or Down key to enable or disable the AC Charge function.

Bat First Setting	
AC Charge:	Disable
Time Interval:	1
Time Active:	Enable
Time:	01:00 - 05:00
Stop Charge SOC:	50%
Charge Power:	50%
OK	



Press the OK key.

Bat First Setting	
AC Charge:	Disable
Time Interval:	1
Time Active:	Enable
Time:	01:00 - 05:00
Stop Charge SOC:	50%
Charge Power:	50%
OK	



Press the Up or Down key to select a time interval.

Bat First Setting	
AC Charge:	Disable
Time Interval:	2
Time Active:	Enable
Time:	01:00 - 05:00
Stop Charge SOC:	50%
Charge Power:	50%
OK	



Press the OK key.

Bat First Setting	
AC Charge:	Disable
Time Interval:	1
Time Active:	Enable
Time:	01:00 - 05:00
Stop Charge SOC:	50%
Charge Power:	50%
OK	



Press the Up or Down key to enable or disable the active time period.

Bat First Setting	
AC Charge:	Disable
Time Interval:	1
Time Active:	Disable
Time:	01:00 - 05:00
Stop Charge SOC:	50%
Charge Power:	50%
OK	



Press the OK key.

Bat First Setting	
AC Charge:	Disable
Time Interval:	1
Time Active:	Enable
Time:	01:00 - 05:00
Stop Charge SOC:	50%
Charge Power:	50%
OK	



Press the Up or Down key to increase or reduce the time duration.

Bat First Setting	
AC Charge:	Disable
Time Interval:	1
Time Active:	Enable
Time:	02:00 - 05:00
Stop Charge SOC:	50%
Charge Power:	50%
OK	



Press the OK key.

Bat First Setting	
AC Charge:	Disable
Time Interval:	1
Time Active:	Enable
Time:	01:00 - 05:00
Stop Charge SOC:	50%
Charge Power:	50%
OK	



Press the Up or Down key to increase or reduce the Stop Charge SOC value.

Bat First Setting	
AC Charge:	Disable
Time Interval:	1
Time Active:	Enable
Time:	01:00 - 05:00
Stop Charge SOC:	51%
Charge Power:	50%
OK	



Press the OK key.

Bat First Setting	
AC Charge:	Disable
Time Interval:	1
Time Active:	Enable
Time:	01:00 - 05:00
Stop Charge SOC:	50%
Charge Power:	50%
OK	



Press the Up or Down key to increase or reduce the Charge Power value.

Bat First Setting	
AC Charge:	Disable
Time Interval:	1
Time Active:	Enable
Time:	01:00 - 05:00
Stop Charge SOC:	50%
Charge Power:	51%
OK	



Press the OK key.

Bat First Setting	
AC Charge:	Disable
Time Interval:	1
Time Active:	Enable
Time:	01:00 - 05:00
Stop Charge SOC:	50%
Charge Power:	50%
OK	



Press the OK key.

Bat First Setting	
AC Charge:	Disable
Time Interval:	1
Time Active:	Enable
Time:	01:00 - 05:00
Stop Charge SOC:	50%
Charge Power:	50%
Setting...	



Wait for 3 seconds.

Bat First Setting	
AC Charge:	Disable
Time Interval:	1
Time Active:	Enable
Time:	01:00 - 05:00
Stop Charge SOC:	50%
Charge Power:	50%
Setting Ok!	

Set Grid First mode in the following steps.

Priority Setting	
1. Bat First Setting	
2. Grid First Setting	



Press the OK key.

Grid First Setting	
Time Interval:	1
Time Active:	Enable
Time:	01:00 - 05:00
Stop Discharge SOC:	50%
Discharge Power:	50%
OK	



Press the OK key.

Grid First Setting	
Time Interval:	1
Time Active:	Enable
Time:	01:00 - 05:00
Stop Discharge SOC:	50%
Discharge Power:	50%
OK	



Press the Up or Down key to select a time interval.

Grid First Setting	
Time Interval:	2
Time Active:	Enable
Time:	01:00 - 05:00
Stop Discharge SOC:	50%
Discharge Power:	50%
OK	



Press the OK key.

Grid First Setting	
Time Interval:	1
Time Active:	Enable
Time:	01:00 - 05:00
Stop Discharge SOC:	50%
Discharge Power:	50%
OK	



Press the Up or Down key to enable or disable the active time period.

Grid First Setting	
Time Interval:	1
Time Active:	Disable
Time:	01:00 - 05:00
Stop Discharge SOC:	50%
Discharge Power:	50%
OK	



Press the OK key.

Grid First Setting	
Time Interval:	1
Time Active:	Disable
Time:	01:00 - 05:00
Stop Discharge SOC:	50%
Discharge Power:	50%
OK	



Press the Up or Down key to increase or reduce the time duration.

Grid First Setting	
Time Interval:	1
Time Active:	Disable
Time:	02:00 - 05:00
Stop Discharge SOC:	50%
Discharge Power:	50%
OK	



Press the OK key.

Grid First Setting	
Time Interval:	1
Time Active:	Disable
Time:	01:00 - 05:00
Stop Discharge SOC:	50%
Discharge Power:	50%
OK	



Press the Up or Down key to increase or reduce the Stop Discharge SOC value.

Grid First Setting	
Time Interval:	1
Time Active:	Disable
Time:	01:00 - 05:00
Stop Discharge SOC:	51%
Discharge Power:	50%
OK	

Grid First Setting	
Time Interval:	1
Time Active:	Disable
Time:	01:00 - 05:00
Stop Discharge SOC:	50%
Discharge Power:	50%
OK	



Press the Up or Down key to increase or reduce the Discharge Power value.

Grid First Setting	
Time Interval:	1
Time Active:	Disable
Time:	01:00 - 05:00
Stop Discharge SOC:	50%
Discharge Power:	51%
OK	



Press the OK key.

Grid First Setting	
Time Interval:	1
Time Active:	Disable
Time:	01:00 - 05:00
Stop Discharge SOC:	50%
Discharge Power:	50%
OK	



Press the OK key.

Grid First Setting	
Time Interval:	1
Time Active:	Disable
Time:	01:00 - 05:00
Stop Discharge SOC:	50%
Discharge Power:	50%
Setting...	



Wait for 3 seconds.

Grid First Setting	
Time Interval:	1
Time Active:	Disable
Time:	01:00 - 05:00
Stop Discharge SOC:	50%
Discharge Power:	50%

**Setting Ok!**

### 7.2.9 Auto Test Setting

The auto test function will be available only if you select "Italy" on the Country Setting page. If you select any other country, the Auto Test Setting page will indicate "Not Support!"

Setting Info
1.Date & Time Setting
2.COM Address Setting
3.Language Setting
4.BAT & Meter Setting
5.Country Setting
6.Off Grid Setting
7.Priority Setting
8.Auto Test Setting
9.Restore Factory Setting



Press the OK key.

AutoTest Setting
Not Support!

If "Italy" is selected, the Auto Test Setting page is shown below.

Setting Info
1.Date & Time Setting
2.COM Address Setting
3.Language Setting
4.BAT & Meter Setting
5.Country Setting
6.Off Grid Setting
7.Priority Setting
8.Auto Test Setting
9.Restore Factory Setting



Press the OK key.

AutoTest Setting	
59.S1:	450.3V 1000ms
27.S1:	340.5V 1000ms
81>.S1:	59.15Hz 100ms
81<.S1:	49.80Hz 100ms
59.S2:	450.3V 1000ms
27.S2:	340.5V 1000ms
81>.S2:	59.15Hz 100ms
81<.S2:	49.80Hz 100ms

**AutoTest Start**

The Real value will vary with time once you start the auto test.

AutoTest Seting	
59.S1:	450.3V 1000ms
27.S1:	340.5V 1000ms
81>.S1:	59.15Hz 100ms
81<.S1:	49.80Hz 100ms
59.S2:	450.3V 1000ms
27.S2:	340.5V 1000ms
81>.S2:	59.15Hz 100ms
81<.S2:	49.80Hz 100ms

**AutoTest Start**



Press the OK key.

AutoTest Setting	
Auto Testing ...	
Step:	59.S1
Limit:	450.3V 1000ms
Real:	400.5V

When an item has been tested, you can see its trigger limit and test result.



AutoTest Setting	
Auto Testing ...	
Step:	59. S1
Limit:	450. 3V 1000ms
Real:	400. 5V

→

The program is updated automatically.

AutoTest Setting	
Auto Testing...	
Step:	59. S1
Limit:	450. 3V 1000ms
Trip:	450. 5V 1000ms
Result:	Pass

When all items have been tested, you can see the auto test results as well as the trigger limits of all items.

AutoTest Setting	
AutoTesting...	
Step:	81<. S2
Limit:	340. 3V 1000ms
Trip:	341. 5V 1000ms
Result:	Pass

→

The program is updated automatically.

AutoTest Setting	
Auto Test Finish	
Result:	Pass
59. S1:	450. 3V 1000ms
27. S1:	340. 5V 1000ms
81>. S1:	59. 5Hz 100ms
81<. S1:	49. 3Hz 100ms
59. S2:	450. 3V 1000ms
27. S2:	340. 5V 1000ms
81>. S2:	59. 5Hz 100ms
81<. S2:	49. 3Hz 100ms

### 7.2.10 Restore Factory Setting

This function can restore calibration data and configuration parameters to default settings, as well as clear energy data and historical fault data. Factory data resetting is as follows:

Setting Info	
1. Date & Time Setting	
2. COM Address Setting	
3. Language Setting	
4. BAT & Meter Setting	
5. Country Setting	
6. Off Grid Setting	
7. Priority Setting	
8. AutoTest Setting	
9. Restore Factory Setting	

→

Press the OK key.

Restore Factory Setting	
Adjust Data:	Disable
Energy:	Disable
Fault History:	Disable
Config Data:	Disable
OK	

→

Press the Up or Down key to enable or disable the reset of calibration data.

Restore Factory Setting	
Adjust Data:	Enable
Energy:	Disable
Fault History:	Disable
Config Data:	Disable
OK	

▼ Press the OK key.

Restore Factory Setting	
Adjust Data:	Disable
Energy:	Disable
Fault History:	Disable
Config Data:	Disable
OK	



Press the Up or Down key to enable or disable the clearing of energy data.

Restore Factory Setting	
Adjust Data:	Disable
Energy:	Enable
Fault History:	Disable
Config Data:	Disable
OK	



Press the OK key.

Restore Factory Setting	
Adjust Data:	Disable
Energy:	Disable
Fault History:	Disable
Config Data:	Disable
OK	



Press the Up or Down key to enable or disable the clearing of fault history.

Restore Factory Setting	
Adjust Data:	Disable
Energy:	Disable
Fault History:	Enable
Config Data:	Disable
OK	



Press the OK key.

Restore Factory Setting	
Adjust Data:	Disable
Energy:	Disable
Fault History:	Disable
Config Data:	Disable
OK	



Press the Up or Down key to enable or disable the reset of configuration data.

Restore Factory Setting	
Adjust Data:	Disable
Energy:	Disable
Fault History:	Disable
Config Data:	Enable
OK	

Restore Factory Setting	
Adjust Data:	Disable
Energy Data:	Disable
Fault History:	Disable
Config Data:	Disable
OK	



Press the OK key.

Restore Factory Setting	
Adjust Data:	Disable
Energy Data:	Disable
Fault History:	Disable
Config Data:	Disable
Setting...	





Wait for 10 seconds.

Restore Factory Setting	
Adjust Data:	Disable
Energy Data:	Disable
Fault History:	Disable
Config Data:	Disable

**Setting Ok!**

### 7.2.11 Anti-reflux Setting

These settings are used to enable/disable the anti-reflux meter, select the meter type, and limit grid power.

<table border="1"> <thead> <tr> <th colspan="2">Setting Info</th> </tr> </thead> <tbody> <tr> <td>10. Anti-Reflex Setting</td> <td></td> </tr> <tr> <td>11. Set Parallel Role</td> <td></td> </tr> </tbody> </table>	Setting Info		10. Anti-Reflex Setting		11. Set Parallel Role		 <p>Press the OK key to go to the Meter Setting page.</p> <p>Press the Up or Down key to enable/disable the meter.</p>	<table border="1"> <thead> <tr> <th colspan="2">Meter Setting</th> </tr> </thead> <tbody> <tr> <td>Anti-Reflex:</td> <td>Disable</td> </tr> <tr> <td>Sensor:</td> <td>CT</td> </tr> <tr> <td>Power Limit</td> <td>000kw</td> </tr> </tbody> </table> <p style="text-align: center;">OK</p>	Meter Setting		Anti-Reflex:	Disable	Sensor:	CT	Power Limit	000kw		
Setting Info																		
10. Anti-Reflex Setting																		
11. Set Parallel Role																		
Meter Setting																		
Anti-Reflex:	Disable																	
Sensor:	CT																	
Power Limit	000kw																	
<p><b>▼ Press the OK key.</b></p>																		
<table border="1"> <thead> <tr> <th colspan="2">Meter Setting</th> </tr> </thead> <tbody> <tr> <td>Anti-Reflex:</td> <td>Disable</td> </tr> <tr> <td>Sensor:</td> <td>CT</td> </tr> <tr> <td>Power Limit</td> <td>000kw</td> </tr> </tbody> </table> <p style="text-align: center;">OK</p>	Meter Setting		Anti-Reflex:	Disable	Sensor:	CT	Power Limit	000kw	 <p>Press the Up or Down key to select the type and brand of the meter.</p>	<table border="1"> <thead> <tr> <th colspan="2">Meter Setting</th> </tr> </thead> <tbody> <tr> <td>Anti-Reflex:</td> <td>Disable</td> </tr> <tr> <td>Sensor:</td> <td>CHINT Meter</td> </tr> <tr> <td>Power Limit</td> <td>000kw</td> </tr> </tbody> </table> <p style="text-align: center;">OK</p>	Meter Setting		Anti-Reflex:	Disable	Sensor:	CHINT Meter	Power Limit	000kw
Meter Setting																		
Anti-Reflex:	Disable																	
Sensor:	CT																	
Power Limit	000kw																	
Meter Setting																		
Anti-Reflex:	Disable																	
Sensor:	CHINT Meter																	
Power Limit	000kw																	
<p><b>▼ Press the OK key.</b></p>																		
<table border="1"> <thead> <tr> <th colspan="2">Meter Setting</th> </tr> </thead> <tbody> <tr> <td>Anti-Reflex:</td> <td>Disable</td> </tr> <tr> <td>Sensor:</td> <td>CT</td> </tr> <tr> <td>Power Limit</td> <td>000kw</td> </tr> </tbody> </table> <p style="text-align: center;">OK</p>	Meter Setting		Anti-Reflex:	Disable	Sensor:	CT	Power Limit	000kw	 <p>Press the Up and Down keys to set limits on the power purchased or sold.</p>	<table border="1"> <thead> <tr> <th colspan="2">Meter Setting</th> </tr> </thead> <tbody> <tr> <td>Anti-Reflex:</td> <td>Disable</td> </tr> <tr> <td>Sensor:</td> <td>CT</td> </tr> <tr> <td>Power Limit</td> <td>100kw</td> </tr> </tbody> </table> <p style="text-align: center;">OK</p>	Meter Setting		Anti-Reflex:	Disable	Sensor:	CT	Power Limit	100kw
Meter Setting																		
Anti-Reflex:	Disable																	
Sensor:	CT																	
Power Limit	000kw																	
Meter Setting																		
Anti-Reflex:	Disable																	
Sensor:	CT																	
Power Limit	100kw																	

<p><b>▼ Press the OK key.</b></p> <div style="border: 1px solid black; padding: 5px; margin: 5px;"> <table style="width: 100%; border-collapse: collapse;"> <tr> <th colspan="2" style="text-align: center; border-bottom: 1px solid black;">Meter Setting</th> </tr> <tr> <td style="width: 60%;">Anti-Reflex:</td> <td style="text-align: right;">Disable</td> </tr> <tr> <td>Sensor:</td> <td style="text-align: right;">CT</td> </tr> <tr> <td>Power Limit</td> <td style="text-align: right;">100kw</td> </tr> </table> <p style="text-align: center; margin-top: 10px;"><b>OK</b></p> </div>	Meter Setting		Anti-Reflex:	Disable	Sensor:	CT	Power Limit	100kw	<p>→</p> <p>Press Enter to save the settings.</p>	<div style="border: 1px solid black; padding: 5px; margin: 5px;"> <table style="width: 100%; border-collapse: collapse;"> <tr> <th colspan="2" style="text-align: center; border-bottom: 1px solid black;">Meter Setting</th> </tr> <tr> <td style="width: 60%;">Anti-Reflex:</td> <td style="text-align: right;">Disable</td> </tr> <tr> <td>Sensor:</td> <td style="text-align: right;">CT</td> </tr> <tr> <td>Power Limit</td> <td style="text-align: right;">100kw</td> </tr> </table> <p style="text-align: center; margin-top: 10px;"><b>Setting OK!</b></p> </div>	Meter Setting		Anti-Reflex:	Disable	Sensor:	CT	Power Limit	100kw
Meter Setting																		
Anti-Reflex:	Disable																	
Sensor:	CT																	
Power Limit	100kw																	
Meter Setting																		
Anti-Reflex:	Disable																	
Sensor:	CT																	
Power Limit	100kw																	

**7.2.12 Set Parallel Role**

<div style="border: 1px solid black; padding: 5px; margin: 5px;"> <table style="width: 100%; border-collapse: collapse;"> <tr> <th colspan="2" style="text-align: center; border-bottom: 1px solid black;">Setting Info</th> </tr> <tr> <td style="width: 60%;">10. Anti-Reflex Setting</td> <td></td> </tr> <tr style="background-color: black; color: white;"> <td>11. Set Parallel Role</td> <td></td> </tr> </table> </div>	Setting Info		10. Anti-Reflex Setting		11. Set Parallel Role		<p>→</p> <p>Press Enter to open the interface.</p> <p>Press the Up or Down key to set the device as either a master or a slave unit.</p>	<div style="border: 1px solid black; padding: 5px; margin: 5px;"> <table style="width: 100%; border-collapse: collapse;"> <tr> <th colspan="2" style="text-align: center; border-bottom: 1px solid black;">Set Parallel Role</th> </tr> <tr style="background-color: black; color: white;"> <td style="width: 60%;">Role:</td> <td style="text-align: right;">1 Phase Master</td> </tr> </table> <p style="text-align: center; margin-top: 10px;">OK</p> </div>	Set Parallel Role		Role:	1 Phase Master
Setting Info												
10. Anti-Reflex Setting												
11. Set Parallel Role												
Set Parallel Role												
Role:	1 Phase Master											
<p><b>▼ Press the OK key.</b></p> <div style="border: 1px solid black; padding: 5px; margin: 5px;"> <table style="width: 100%; border-collapse: collapse;"> <tr> <th colspan="2" style="text-align: center; border-bottom: 1px solid black;">Set Parallel Role</th> </tr> <tr> <td style="width: 60%;">Role: 2</td> <td style="text-align: right;">Slave</td> </tr> </table> <p style="text-align: center; margin-top: 10px;"><b>OK</b></p> </div>	Set Parallel Role		Role: 2	Slave	<p>→</p> <p>Press the Enter key to confirm the settings and go to the next step.</p>	<div style="border: 1px solid black; padding: 5px; margin: 5px;"> <table style="width: 100%; border-collapse: collapse;"> <tr> <th colspan="2" style="text-align: center; border-bottom: 1px solid black;">Set Parallel Role</th> </tr> <tr> <td style="width: 60%;">Role: 2</td> <td style="text-align: right;">Slave</td> </tr> </table> <p style="text-align: center; margin-top: 10px;"><b>Setting Ok!/Fail!</b></p> </div>	Set Parallel Role		Role: 2	Slave		
Set Parallel Role												
Role: 2	Slave											
Set Parallel Role												
Role: 2	Slave											

## Chapter 8 System Debugging

### 8.1 LCD Screen and Keys

#### 8.1.1 LCD Screen

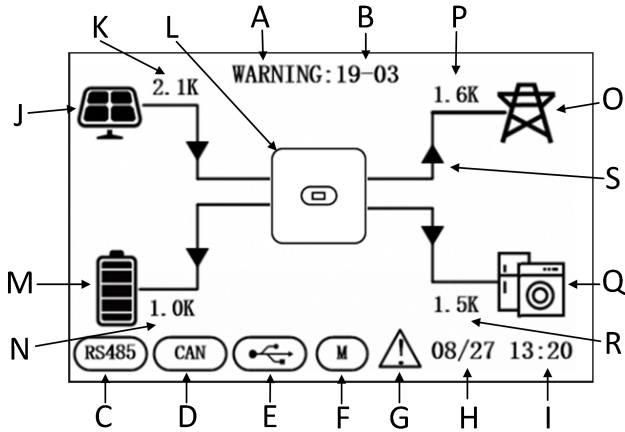

Fig. 8-1

Position	Description
A	State
B	Fault code
C	RS485 communication
D	CAN communication
E	USB port
F	Smart meter
G	Fault warning
H	Date
I	Time
J	PV input
K	PV power
L	Hybrid Inverter
M	Battery indicator (20% × 5 bars)
N	Battery power

O	Power grid
P	Grid power
Q	Critical load
R	Load power
S	Energy flow arrow

8.1.2 LED Screen and Keys

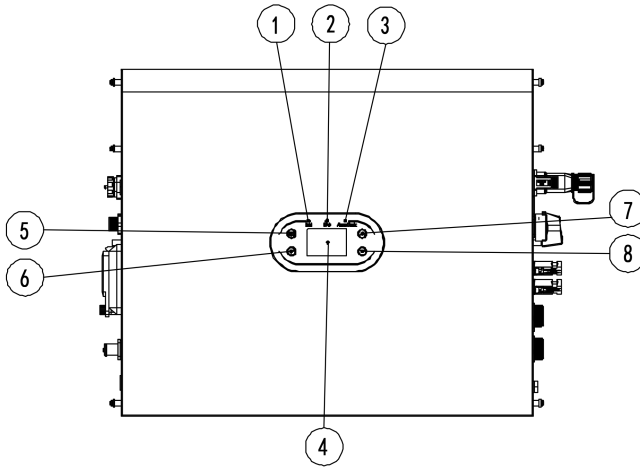

Fig. 8-2

Position	Description
1	Green LED remaining on: in the on-grid state.
	Green LED flashing: during the power-on self-test.
	Green and yellow LED flashing: during the programming process.
2	Yellow LED remaining on: in the off-grid state.
3	Red LED remaining on: in the fault state.
4	LCD screen
5	Return key
6	Enter key
7	Up key
8	Down key

## 8.2 Working Mode

### 8.2.1 Normal Mode

In normal mode, the inverter may work in on-grid state or off-grid state.

#### On-grid State

When the hybrid inverter works in on-grid state, you can select a priority mode as needed. On the LCD screen, you can only set one period for each priority mode; while on the App, you can set up to three periods for each priority mode.

1. Load First: This is the default priority mode. When the system works in this mode, the PV energy will be provided to the load first. When the PV energy is not sufficient to meet the load need, the battery will begin to supply power. When the PV energy is more than the load power, the excess power will be stored in the battery. If no battery is connected or the battery is already full, the excess power will be supplied to the grid (if anti-reflux protection is not enabled).

2. Bat First: when the system works in this mode, the battery will be charged first. To charge the battery with AC power, you need to enable the AC Charge function and set the time interval and battery SOC. If the AC Charge function is not enabled, the hybrid inverter will only charge the battery with PV energy. You can also set the discharge power (maximum discharge percentage of the battery). In Bat First mode, the actual discharge energy of the battery will not exceed the set percentage.

3. Grid First: When the system works in this mode, the PV energy will be supplied to the grid first. Users can export energy to the grid during peak hours. You need to set the time interval and battery SOC. You can also set the discharge power (maximum discharge percentage of the battery). In Grid First mode, the actual discharge energy of the battery will not exceed the set percentage.

#### Off-grid State

In case of grid power failure, the system will automatically get into the off-grid state (you can disable this function as instructed in Section 9.1).

In this state, the system will output voltage via the EPS port and power the load by the battery and solar PV panel. Please note that the load at the EPS port should not exceed the maximum output power (6000W) of the inverter.

Note:

1. In Grid First mode or Bat First mode, you can only set one period on the LCD screen. If you need to set more periods, please use Solarman App.

2. To charge the battery with AC power, you need to enter your login password and then enable the AC Charge function.

### 8.2.2 Fault State

INVT Hybrid Inverter has an intelligent control system that can continuously monitor and adjust the state of the system. In case of a system fault or device fault, the fault information will be displayed on the LCD screen and

the corresponding LED will be turned on.

Note:

- A) See Section 10.1 for more fault information.
- B) Some of the fault information is intended to remind you of possible internal faults of the inverter.

### 8.2.3 Firmware Upgrade

Do not turn off the power during the firmware upgrade progress. The system will automatically proceed to working mode at the end of firmware upgrade.

### 8.2.4 Self-test State

Before entering the working mode, the system will get into the power-on self-test state. If no fault is detected, the system will proceed to working mode; otherwise, it will get into the fault state.

### 8.2.5 Standby State

When no fault is detected and a certain operating condition has not been met, the system will get into the standby state.

### 8.2.6 Power-off State

To stop the operation of the hybrid inverter, please disconnect all energy sources to enter automatic shutdown.

Below are the shutdown steps:

1. Disconnect the PV side;
2. Turn off the BAT switch;
3. Disconnect the power grid. Both the LED light and LCD screen will be turned off.

Note: At the end of the above steps, please wait at least 5 minutes before proceeding to other operations.

<b>NOTE</b>
At the end of the above steps, please wait at least 5 minutes before proceeding to other operations.

## 8.3 Setting Parameters in Solarman App

Note: To ensure normal operation of the inverter, use Solarman App to set the parameters of the hybrid inverter first.

<b>NOTE</b>
To ensure normal operation of the inverter, please use Solarman App to set the parameters of the hybrid inverter first.

Solarman is a mobile App that can communicate with the hybrid inverter via Wi-Fi or GPRS. It allows you to:

1. Check the running data, software version and fault information of the inverter;
2. Set the grid parameters and communication parameters of the inverter;
3. Perform maintenance of the inverter;
4. Update the software version of the inverter.

For more functions of the Solarman App, please read its User Guide, which is available on <https://www.invt.com/>.



## Chapter 9 System Maintenance

INVT Hybrid Inverter has undergone a series of tests before delivery. To maintain and extend the service life of the inverter, you need to perform necessary routine maintenance in addition to using it in strict accordance with this Manual.

Make sure the inverter is disconnected from the power supply.
---

To operate the inverter, please wear personal protective equipment.
---

### 9.1 Regular Maintenance of Inverter

Maintenance Item	Process	Interval
Saving the inverter's running data	Use the monitoring software to read the inverter data in real time, and back up the recorded data periodically. Save the running data, parameters and logs of the inverter recorded by the monitoring software to a file. Check the monitoring software and view the parameter settings of the inverter through the hand-held device.	Every quarter
Inverter Running condition of the inverter	Observe whether the inverter is installed securely, damaged or deformed. Check if there is any abnormal sound during operation. Check the variables when the system is running in on-grid state. Check whether the heating of the inverter housing is normal, and use the thermal imager to monitor the heating of the system.	Every six months
Cleaning the inverter	Check the ambient humidity and dust around the inverter. If they affect the heat dissipation of the inverter, shut down the inverter and turn off the power supply, and clean the inverter with a soft brush or dry cloth after it cools down.	Every six months
DC switch	Check whether the DC switch functions properly by turning it on and off 10 times consecutively.	Every year
Electrical Connection	Check whether the cable connections and the terminals of the inverter become loose. Check the cables for damage, especially whether there are any cuts on the cable sheath that may come in contact with metal surface.	Every six months
Sealing	Check whether the sealing of the cable holes meets the requirements. If any cable hole is not sealed or shows a large sealing gap, re-seal it.	Every year
Safety function	Check the LCD screen and the system shutdown function. Simulate a shutdown and check the shutdown signal communication. Check the warning labels and replace them if necessary.	Every year

## 9.2 Powering Off the Inverter

**DANGER**

- To perform maintenance of the inverter, please power off the inverter so as to avoid damage to the inverter and avoid the risk of electric shock.
- When the inverter is powered off, it will take time for the internal components to discharge. Please wait for the period specified on the label until the inverter is fully discharged.

Step 1: Disconnect the on-grid AC circuit breaker of the inverter.

Step 2: Disconnect the back-up AC circuit breaker of the inverter.

Step 3: Disconnect the EPS circuit breaker between the inverter and battery.

## 9.3 Removing the Inverter

Step 1: Disconnect all electrical connections of the inverter, including the DC wire, AC wire, communication cable, communication module and grounding wire.

Step 2: Remove all securing screws.

Step 3: Detach the inverter from the battery.

Step 4: Keep the inverter properly for future use, according to the storage environment requirements.

## 9.4 Scrapping the Inverter

If the inverter cannot be used any longer, dispose of the inverter according to the electrical waste disposal requirements of the laws and regulations of your country/region. Do not dispose of the inverter as household waste.

## Chapter 10 Troubleshooting

### Fault Codes and Troubleshooting



**WARNI  
NG**

If you are not professional at troubleshooting, contact your dealer for help. Please wear personal protective equipment and power off the inverter before troubleshooting!

This Chapter lists the faults by a list of fault codes, so that you can find troubleshooting actions quickly.

You can use the following methods to do troubleshooting. If they cannot help you, contact our After-sales Service Center.

Please provide the following information to our After-sales Service Center so that we can help you more quickly.

- Model No. of the inverter: \_\_\_\_\_;
  - SN of the inverter: \_\_\_\_\_;
  - System version of the inverter — version 1: \_\_\_\_\_;  
— Version 2: \_\_\_\_\_;
  - MCU software version: \_\_\_\_\_;
  - Fault code: \_\_\_\_\_;
  - Installation environment of the inverter: \_\_\_\_\_;
- Description of fault: \_\_\_\_\_.

Table 10-1 Fault Codes of Inverter

No.	Fault Type	Fault Code	Fault Information	Actions
1	PV voltage error	01-01	Low PV voltage	Check whether the PV panel is connected properly, damaged, covered with dust, or blocked by any objects.
		01-02	High PV voltage	Check whether the PV panel is connected properly, and whether the PV voltage is higher than the maximum working voltage of the inverter.
		01-03	Short circuit of PV panel	Check whether the PV panel is short-circuited.
2	Bus voltage error	03-01	Low Bus voltage	This fault usually occurs in the early morning. Please check the cleanliness of the PV panel surface.
		03-02	High Bus voltage	Check whether the PV panel is connected properly, and whether the PV voltage is higher than the maximum working voltage of the inverter.
		03-04	Over-voltage of hardware Bus	Restart the inverter. If the fault still exists, contact your dealer.
3	Over-current	05-01	Over-current of inverter hardware	Restart the inverter. If the fault still exists, contact your dealer.
		05-02	Over-current of inverter software	
		05-03	Over-current of boost hardware	
		05-04	Over-current of boost software	
		05-05	Auxiliary power hardware TZ failure	
		05-06	TZ Over-voltage of Bus hardware	
		05-07	Hardware TZ failure at LLC side	
		05-08	Over-current of buck-boost software	
4	Temperature	06-01	Abnormal inverter	Check the inverter temperature. If the

	error		temperature	temperature is too high, cool the inverter down before use.
		06-02	Abnormal Boost temperature	
		06-03	Abnormal radiator temperature	
		06-04	Abnormal ambient temperature	
		06-05	Abnormal buck-boost temperature	
		06-06	Open circuit of NTC thermistor	
5	Insulation monitoring error	07-01	Insulation monitoring error	Check whether the inverter and PV panel are grounded reliably. Power off the inverter for 5 minutes and then power it on again. If the fault still exists, contact your dealer.
6	Driver error	08-01	Driver error	Restart the inverter. If the fault still exists, contact your dealer.
7	Communication error	09-01	Communication error from ARM to master DSP	Restart the inverter. If the fault still exists, contact your dealer.
		09-02	Communication error from master DSP to ARM	
		09-03	Communication error from ARM to slave DSP	
		09-04	Communication error from slave DSP to ARM	Restart the inverter. If the fault still exists, contact your dealer.
		09-05	Communication error between master and slave chips - master chip failure	
		09-06	Communication error between master and slave chips - slave chip failure	Restart the inverter. If the fault still exists, contact your dealer.
		09-07	Communication error between DSP and AFCI	Restart the inverter. If the fault still exists, contact your dealer.

8	Leakage current error	10-01	High static leakage current	1. If the fault occurs occasionally, it may be caused by accidental abnormality of external cables. You can restart the inverter to resume normal operation.
		10-02	Abrupt fault of 30mA	
		10-03	Abrupt fault of 60mA	2. If the fault occurs frequently or lasts long, check whether the PV string is grounded reliably.
		10-04	Abrupt fault of 150mA	
9	Relay failure	11-01	Open circuit of relay	Restart the inverter. If the fault still exists, contact your dealer.
		11-02	Short circuit of relay	
10	Internal fan failure	12-01	Internal fan failure	Restart the inverter. If the fault still exists, contact your dealer.
11	DCI error	14-01	DCI error of R-phase	Check whether the inverter and PV panel are grounded reliably. Power off the inverter for 5 minutes and then power it on again. If the fault still exists, contact your dealer.
12	Consistency error	19-01	Inconsistent AC voltage values	Restart the inverter. If the fault still exists, contact your dealer.
		19-02	Inconsistent Bus voltage values	
		19-03	Inconsistent ISO voltage values	
		19-04	Inconsistent PV voltage values	
		19-05	Inconsistent GFCI	
		19-06	Bus voltage sampling error	
		19-07	PV current sampling error	
13	AC voltage error	31-01	Level-1 under-voltage of AC power	1. If the fault occurs occasionally, it may be caused by momentary abnormality of the power grid. The inverter will resume normal operation when the power grid gets back to normal.
		31-02	Level-1 over-voltage of AC power	2. If the fault occurs frequently, check whether the power grid is connected properly.
		31-03	No AC voltage	Check whether the AC power is connected properly.

		31-04	Level-2 under-voltage of AC power	<p>1. If the fault occurs occasionally, it may be caused by momentary abnormality of the power grid. The inverter will resume normal operation when the power grid gets back to normal.</p> <p>2. If the fault occurs frequently, check whether the power grid is connected properly.</p>
		31-05	Level-2 over-voltage of AC power	
		31-06	Startup under-voltage of AC power	
		31-07	Startup over-voltage of AC power	
		31-08	Transient over-voltage of interruptions	
		31-09	Anti-islanding over-voltage	
		31-10	Oscillation of grid voltage	
14	AC frequency error	33-01	Level-1 under-frequency of AC power	<p>1. If the fault occurs occasionally, it may be caused by momentary abnormality of the power grid. The inverter will resume normal operation when the power grid gets back to normal.</p> <p>2. If the fault occurs frequently, check whether the power grid is connected properly.</p>
		33-02	Level-1 over-frequency of AC power	
		33-03	Level-2 under-frequency of AC power	
		33-04	Level-2 over-frequency of AC power	
		33-05	Startup under-frequency of AC power	
		33-06	Startup over-frequency of AC power	
15	Remote shutdown	37-01	Remote shutdown instruction	Check whether anyone is trying to shut down the inverter remotely.
16	AFCl error	38-01	Failure of PV string 1	Please turn off the inverter and open the input and output switches, and turn on the inverter again 5 minutes later. If the fault still exists, contact your dealer.
		38-02	Failure of PV string 2	

17	Power-on self-test error of AFCI	39-01	Power-on self-test error of PV string 1	Please turn off the inverter and open the input and output switches, and turn on the inverter again 5 minutes later. If the fault still exists, contact your dealer.
		39-02	Power-on self-test error of PV string 2	
18	Auto Test failure	41-01	Auto Test failure	Please turn off the inverter and open the input and output switches, and turn on the inverter again 5 minutes later. If the fault still exists, contact your dealer.
19	N-PE fault	42-01	N-PE voltage error	Check whether the AC wires are connected properly and reliably to the inverter.
20	Power-on self-test error of leakage current	43-01	Leakage current sensor failure	Please turn off the inverter and open the input and output switches, and turn on the inverter again 5 minutes later. If the fault still exists, contact your dealer.
21	PV string detection error	44-01	PV string failure	Please turn off the inverter and open the input and output switches, and turn on the inverter again 5 minutes later. If the fault still exists, contact your dealer.
22	Auxiliary power error	45-01	Auxiliary power failure	Please turn off the inverter and open the input and output switches, and turn on the inverter again 5 minutes later. If the fault still exists, contact your dealer.
23	Short circuit of EPS	46-01	Short circuit of EPS	Check whether the output wiring is correct at the EPS port.
24	Parallel fault	40-1	Multiple host failure	Please check the master slave settings
		40-2	Parallel CAN communication failure	Please check the parallel CAN wiring
		40-3	Host loss fault	1. Please check the parallel CAN wiring 2. Please check the master slave settings
		40-4	Synchronous zero crossing fault	1. Please check the parallel CAN wiring 2. Please check the master slave settings



Table 10-2 Warning Codes of Inverter

No.	Fault Type	Fault Code	Fault Information	Displayed Information
1	Low fan speed	01-07	Internal fan 1	Please turn off the inverter and open the input and output switches, and turn on the inverter again 5 minutes later. If the fault still exists, contact your dealer.
2	Communication of anti-reflux meter	04-01	Meter failure	Check whether the smart meter is connected properly and supplies power normally.
		04-08	Communication error of meter	Check whether the smart meter is connected properly and supplies power normally.
		04-16	CT cable error	Check whether the CT cable is connected properly.
3	Out-of-range grid voltage	05-00	Out-of-range voltage	1. If the fault occurs occasionally, it may be caused by momentary abnormality of the power grid. The inverter will resume normal operation when the power grid gets back to normal. 2. If the fault occurs frequently, check whether the power grid is connected properly.
4	Short circuit of PV	06-01	Short circuit of PV1	Check whether the PV input is normal and whether the circuit is short.
		06-02	Short circuit of PV2	
5	Overload	07-01	EPS overload	Reduce the load at the EPS port.
6	Full battery	46-01	Full battery	The battery is fully charged.
7	Low battery voltage	47-01	The battery needs to be charged.	Please charge the battery soon.
		47-02	The battery can only be charged.	Check the mode settings and charge the battery.
8	EPS overload alarm	07-01	EPS power exceeds 1.5 times	Please reduce the EPS end load power
		07-02	EPS power exceeds 1.2 times	
		07-03	EPS power exceeds 1.1 times	
		07-04	EPS current exceeds 1.5 times	
		07-05	EPS current exceeds 1.2 times	
		07-06	EPS current exceeds 1.1 times	

## Chapter 11 Product Specifications

Model	XD3KTL-AIO	XD3K6TL-AIO	XD4KTL-AIO	XD4K6TL-AIO	XD5KTL-AIO	XD6KTL-AIO
<b>Battery Parameters</b>						
Battery type	Lithium Battery					
Battery voltage (V)	40-60					
Maximum charge/discharge current (A)	100					
Communication mode	CAN					
<b>DC input</b>						
Maximum input power (W)	4500	5400	6000	6900	7500	9000
Maximum input voltage (V)	600					
Start-up voltage (V)	100					
Rated voltage (V)	240	240	270	300	330	360
MPPT voltage range (V)	100-550					
MPPT channels	2					
Maximum input current (A)	16					
Maximum input short-circuit current (A)	20					
<b>AC output</b>						
Rated output power (VA)	3000	3680	4000	4600	5000	6000
Maximum output power (VA)	3300	3680	4400	4600	5500	6600
Maximum output current (A)	15	16	20	20.9	22.7	30
Rated voltage (V)	230					
Rated frequency (Hz)	50					
Total harmonic distortion of current (@ rated power)	<3%					
Power factor	0.8 lead ~ 0.8 lag					
<b>EPS output</b>						
Maximum output power (VA)	3000	3680	4000	4600	5000	6000
Maximum output current (A)	15	16	20	20.9	22.7	30
Peak output power, time (KW, s)	4.5,10	5.4,10	6,10	6.9,10	7.5,10	9,10

Rated output voltage, frequency (V, Hz)	230, 50
THDv (@ rated power)	<3%
Switching time (ms)	<10
<b>Efficiency</b>	
Maximum efficiency	>97.5%
European efficiency	>97.2%
Charge-discharge efficiency	>95%
<b>Protection</b>	
Anti-reverse / insulation impedance / grounding protection	Available
Over-current & over-voltage protection	Available
Battery soft start protection	Available
AFCI protection	Optional
Lightning protection	Level II
<b>General Specifications</b>	
Ambient temperature	-30°C~+60°C
Standby power (W)	<10
Topology	High-frequency isolation (for battery)
Ingress protection	IP65
RH	0~100%
Communication	RS485 & CAN & WIFI & 4G & LAN & Bluetooth
Maximum working altitude (m)	4000
Noise	≤25dB
Cooling mode	Natural cooling
Display	LCD
Dimension	640*470*210
Weight	30.2Kg



Hotline: +86 400 700 9997

E-mail: [solar-service@invt.com.cn](mailto:solar-service@invt.com.cn)

Website: [www.invt-solar.com](http://www.invt-solar.com)

---

INVT Solar Technology (Shenzhen) Co., Ltd.

2th Floor, Block B, INVT Guangming Technology

Building, Songbai Road, Matian, Guangming District, Shenzhen, China

This Manual is subject to change without prior notice due to product improvements. All rights reserved. Reproduction is prohibited without prior written permission.

2023010 (V1.0)